

2023  
collection



 M I R Z A

**SOFAS  
SECTIONALS  
& MODULARS**



# SIMONE

MX2010

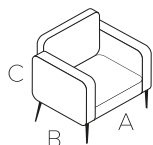

|          | (3D) SOFÁ |    | (2D) LOVESEAT |    | (1D) SILLÓN |    |
|----------|-----------|----|---------------|----|-------------|----|
|          | cm        | in | cm            | in | cm          | in |
| <b>A</b> | 223       | 88 | 168           | 67 | 105         | 42 |
| <b>B</b> | 96        | 38 | 96            | 38 | 96          | 38 |
| <b>C</b> | 78        | 31 | 78            | 31 | 78          | 31 |

# SIMONE

MX2011

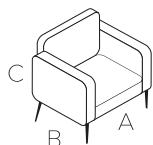

|   | (3D) SOFÁ |    | (2D) LOVESEAT |    | (1D) SILLÓN |    |
|---|-----------|----|---------------|----|-------------|----|
|   | cm        | in | cm            | in | cm          | in |
| A | 223       | 88 | 168           | 67 | 105         | 42 |
| B | 96        | 38 | 96            | 38 | 96          | 38 |
| C | 78        | 31 | 78            | 31 | 78          | 31 |

# SOHO

MX2020

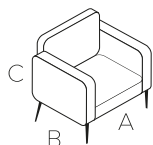

|          | (3D) SOFÁ |    | (2D) LOVESEAT |    | (1D) SILLÓN |    |
|----------|-----------|----|---------------|----|-------------|----|
|          | cm        | in | cm            | in | cm          | in |
| <b>A</b> | 229       | 91 | 188           | 75 | 137         | 54 |
| <b>B</b> | 95        | 38 | 95            | 38 | 95          | 38 |
| <b>C</b> | 86        | 34 | 86            | 34 | 86          | 34 |

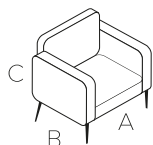

| (3D) SOFÁ    |    | (2D) LOVESEAT |    | (1D) SILLÓN |    |
|--------------|----|---------------|----|-------------|----|
| cm           | in | cm            | in | cm          | in |
| <b>A</b> 229 | 91 | 188           | 75 | 137         | 54 |
| <b>B</b> 95  | 38 | 95            | 38 | 95          | 38 |
| <b>C</b> 86  | 34 | 86            | 34 | 86          | 34 |

# SOHO

MX2021

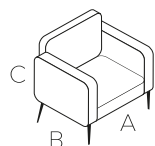

|          | (3D) SOFÁ |    | (2D) LOVESEAT |    | (1D) SILLÓN |    |
|----------|-----------|----|---------------|----|-------------|----|
|          | cm        | in | cm            | in | cm          | in |
| <b>A</b> | 229       | 91 | 188           | 75 | 137         | 54 |
| <b>B</b> | 95        | 38 | 95            | 38 | 95          | 38 |
| <b>C</b> | 86        | 34 | 86            | 34 | 86          | 34 |

# BROADWAY

# MX2030

\* Pillows and accessories sold separately.  
Accesorios y cojines se venden por separado

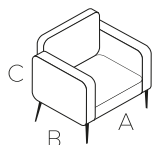

(2LE/2RE) LOVESEAT  
CON BRAZO

|          | cm  | in |
|----------|-----|----|
| <b>A</b> | 182 | 72 |
| <b>B</b> | 94  | 38 |
| <b>C</b> | 88  | 35 |

(LS/RS) CHAISE  
CON BRAZO

|  | cm  | in |
|--|-----|----|
|  | 102 | 41 |
|  | 154 | 61 |
|  | 88  | 35 |



# BROADWAY

# MX2030

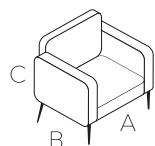

(2LE/2RE) LOVESEAT  
CON BRAZO

|          | cm  | in |
|----------|-----|----|
| <b>A</b> | 182 | 72 |
| <b>B</b> | 94  | 38 |
| <b>C</b> | 88  | 35 |

(LS/RS) CHAISE  
CON BRAZO

|  | cm  | in |
|--|-----|----|
|  | 102 | 41 |
|  | 154 | 61 |
|  | 88  | 35 |

# WINSTON

MX2050

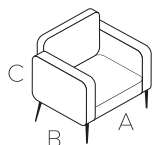

(2S) LOVESEAT SIN BRAZOS

|          | cm  | in |
|----------|-----|----|
| <b>A</b> | 224 | 89 |
| <b>B</b> | 114 | 45 |
| <b>C</b> | 75  | 30 |

# WINSTON

MX2051

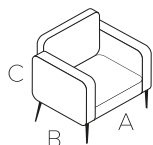

(2S) LOVESEAT SIN BRAZOS

|          | cm  | in |
|----------|-----|----|
| <b>A</b> | 224 | 89 |
| <b>B</b> | 114 | 45 |
| <b>C</b> | 75  | 30 |

# LUKA

# MX2080

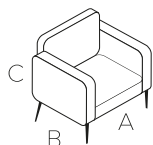

(2LE/2RE) LOVESEAT  
CON BRAZO

|          | cm  | in |
|----------|-----|----|
| <b>A</b> | 175 | 69 |
| <b>B</b> | 93  | 37 |
| <b>C</b> | 83  | 33 |

(R) ESQUINERO

|  | cm | in |
|--|----|----|
|  | 93 | 37 |
|  | 93 | 37 |
|  | 83 | 33 |

(S) SILLON SIN BRAZOS

|  | cm | in |
|--|----|----|
|  | 84 | 34 |
|  | 93 | 37 |
|  | 83 | 33 |

(3D) SOFÁ

|  | cm  | in |
|--|-----|----|
|  | 230 | 91 |
|  | 93  | 37 |
|  | 83  | 33 |

(2D) LOVESEAT

|  | cm  | in |
|--|-----|----|
|  | 190 | 75 |
|  | 93  | 37 |
|  | 83  | 33 |

(1D) SILLÓN

|  | cm  | in |
|--|-----|----|
|  | 130 | 52 |
|  | 93  | 37 |
|  | 83  | 33 |

# LUKA

# MX2080

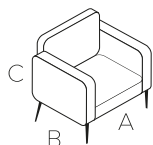

(2LE/2RE) LOVESEAT  
CON BRAZO

|          | cm  | in |
|----------|-----|----|
| <b>A</b> | 175 | 69 |
| <b>B</b> | 93  | 37 |
| <b>C</b> | 83  | 33 |

(R) ESQUINERO

| cm | in |
|----|----|
| 93 | 37 |
| 93 | 37 |
| 83 | 33 |

(S) SILLON SIN BRAZOS

| cm | in |
|----|----|
| 84 | 34 |
| 93 | 37 |
| 83 | 33 |

(3D) SOFÁ

| cm  | in |
|-----|----|
| 230 | 91 |
| 93  | 37 |
| 83  | 33 |

(2D) LOVESEAT

| cm  | in |
|-----|----|
| 190 | 75 |
| 93  | 37 |
| 83  | 33 |

(1D) SILLÓN

| cm  | in |
|-----|----|
| 130 | 52 |
| 93  | 37 |
| 83  | 33 |

# LUKA

# MX2080

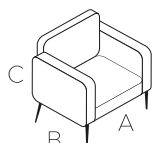

(2LE/2RE) LOVESEAT  
CON BRAZO

|          | cm  | in |
|----------|-----|----|
| <b>A</b> | 175 | 69 |
| <b>B</b> | 93  | 37 |
| <b>C</b> | 83  | 33 |

(R) ESQUINERO

| cm | in |
|----|----|
| 93 | 37 |
| 93 | 37 |
| 83 | 33 |

(S) SILLON SIN BRAZOS

| cm | in |
|----|----|
| 84 | 34 |
| 93 | 37 |
| 83 | 33 |

(3D) SOFÁ

| cm  | in |
|-----|----|
| 230 | 91 |
| 93  | 37 |
| 83  | 33 |

(2D) LOVESEAT

| cm  | in |
|-----|----|
| 190 | 75 |
| 93  | 37 |
| 83  | 33 |

(1D) SILLÓN

| cm  | in |
|-----|----|
| 130 | 52 |
| 93  | 37 |
| 83  | 33 |

# OSLO

# MX2090

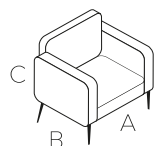

|          | <u>(LS/RS) CHAISE CON BRAZO</u> |    | <u>(2LE/2RE) LOVESEAT CON BRAZO</u> |    |
|----------|---------------------------------|----|-------------------------------------|----|
|          | cm                              | in | cm                                  | in |
| <b>A</b> | 112                             | 45 | 191                                 | 76 |
| <b>B</b> | 163                             | 65 | 97                                  | 39 |
| <b>C</b> | 80                              | 32 | 80                                  | 32 |

# OSLO

# MX2090

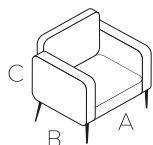

|          | <u>(LS/RS) CHAISE CON BRAZO</u> |    | <u>(2LE/2RE) LOVESEAT CON BRAZO</u> |    |
|----------|---------------------------------|----|-------------------------------------|----|
|          | cm                              | in | cm                                  | in |
| <b>A</b> | 112                             | 45 | 191                                 | 76 |
| <b>B</b> | 163                             | 65 | 97                                  | 39 |
| <b>C</b> | 80                              | 32 | 80                                  | 32 |



# JULIA

MX2110

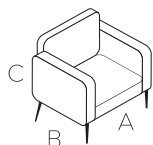

| (2LE/2RE) LOVESEAT CON BRAZO |     | (R1) ESQUINERO DIAMANTE |     | (2S) LOVESEAT SIN BRAZOS |     | (LS/RS) CHAISE CON BRAZO |     | (ST) TABURETE |     | (ST1) TABURETE |     | (3D) SOFÁ |     | (2D) LOVESEAT |     |    |
|------------------------------|-----|-------------------------|-----|--------------------------|-----|--------------------------|-----|---------------|-----|----------------|-----|-----------|-----|---------------|-----|----|
| cm                           | in  | cm                      | in  | cm                       | in  | cm                       | in  | cm            | in  | cm             | in  | cm        | in  | cm            | in  |    |
| <b>A</b>                     | 179 | 71                      | 158 | 63                       | 144 | 57                       | 145 | 58            | 116 | 46             | 108 | 43        | 259 | 102           | 220 | 87 |
| <b>B</b>                     | 116 | 46                      | 158 | 63                       | 116 | 46                       | 160 | 63            | 108 | 43             | 73  | 29        | 116 | 46            | 116 | 46 |
| <b>C</b>                     | 68  | 27                      | 68  | 27                       | 68  | 27                       | 68  | 27            | 43  | 17             | 43  | 17        | 68  | 27            | 68  | 27 |

# JULIA

# MX2110

\* Pillows and accessories sold separately.  
Accesorios y cojines se venden por separado

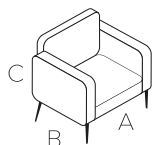

| (2LE/2RE) LOVESEAT CON BRAZO |     | (R1) ESQUINERO DIAMANTE |     | (2S) LOVESEAT SIN BRAZOS |     | (LS/RS) CHAISE CON BRAZO |     | (ST) TABURETE |     | (ST1) TABURETE |     | (3D) SOFÁ |     | (2D) LOVESEAT |     |    |
|------------------------------|-----|-------------------------|-----|--------------------------|-----|--------------------------|-----|---------------|-----|----------------|-----|-----------|-----|---------------|-----|----|
| cm                           | in  | cm                      | in  | cm                       | in  | cm                       | in  | cm            | in  | cm             | in  | cm        | in  | cm            | in  |    |
| <b>A</b>                     | 179 | 71                      | 158 | 63                       | 144 | 57                       | 145 | 58            | 116 | 46             | 108 | 43        | 259 | 102           | 220 | 87 |
| <b>B</b>                     | 116 | 46                      | 158 | 63                       | 116 | 46                       | 160 | 63            | 108 | 43             | 73  | 29        | 116 | 46            | 116 | 46 |
| <b>C</b>                     | 68  | 27                      | 68  | 27                       | 68  | 27                       | 68  | 27            | 43  | 17             | 43  | 17        | 68  | 27            | 68  | 27 |

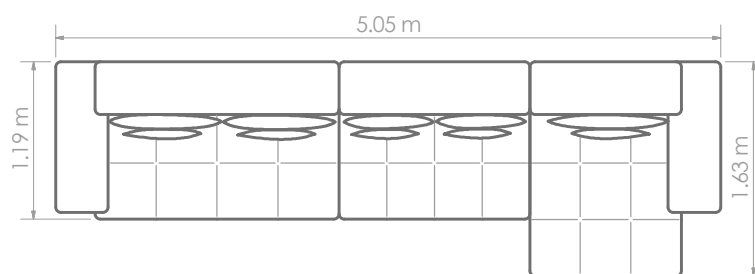
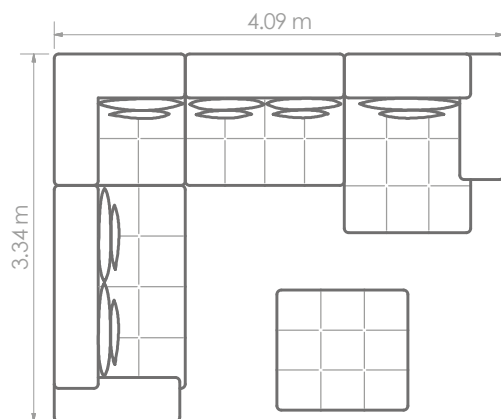
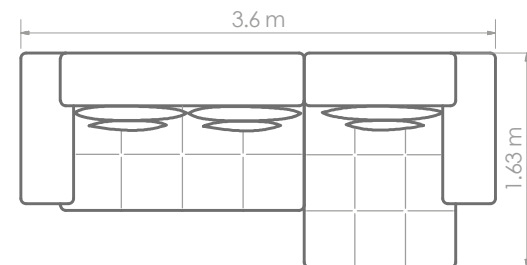
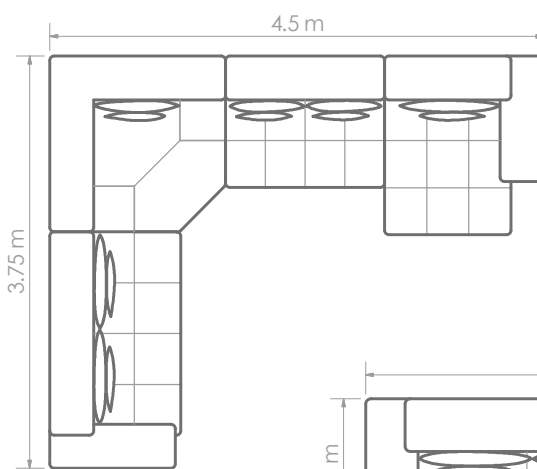
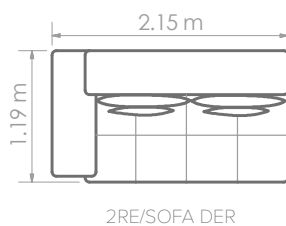
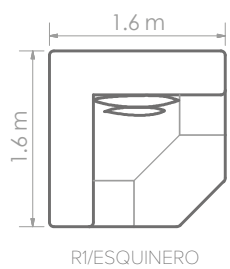
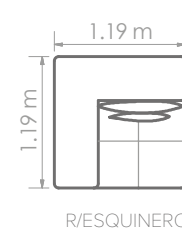
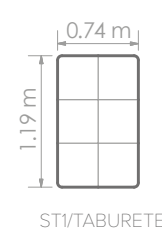
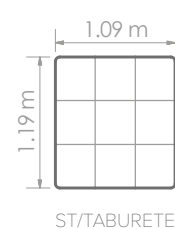
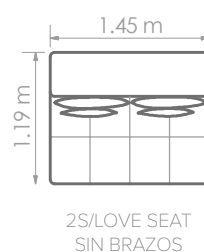
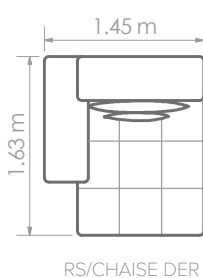
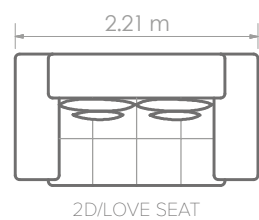
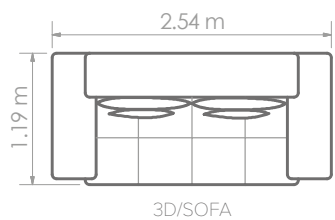

# HAMILTON

MX2120

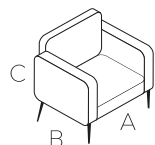

(2LE/2RE) LOVESEAT  
CON BRAZO

|          | cm  | in |
|----------|-----|----|
| <b>A</b> | 177 | 70 |
| <b>B</b> | 90  | 36 |
| <b>C</b> | 73  | 29 |

(LS/RS) CHAISE CON BRAZO

|  | cm  | in |
|--|-----|----|
|  | 100 | 40 |
|  | 165 | 65 |
|  | 73  | 29 |

(ST) TABURETE

|  | cm  | in |
|--|-----|----|
|  | 177 | 70 |
|  | 73  | 29 |
|  | 45  | 18 |

# HAMILTON

MX2120

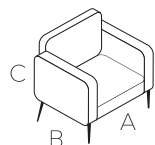

(2LE/2RE) LOVESEAT  
CON BRAZO

|          | cm  | in |
|----------|-----|----|
| <b>A</b> | 177 | 70 |
| <b>B</b> | 90  | 36 |
| <b>C</b> | 73  | 29 |

(LS/RS) CHAISE CON BRAZO

|  | cm  | in |
|--|-----|----|
|  | 100 | 40 |
|  | 165 | 65 |
|  | 73  | 29 |

(ST) TABURETE

|  | cm  | in |
|--|-----|----|
|  | 177 | 70 |
|  | 73  | 29 |
|  | 45  | 18 |

# FREEMAN

MX2130

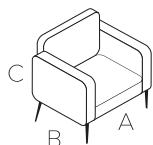

|          | (2LE/2RE) LOVESEAT<br>CON BRAZO |    | (1LE/1RE) SILLÓN<br>CON BRAZO |    | (2S) LOVESEAT SIN BRAZOS |    | (R) ESQUINERO |    | (S) SILLÓN SIN BRAZOS |    | (LS/RS) CHAISE CON BRAZO |    | (ST) TABURETE |    | (ST1) TABURETE |    |
|----------|---------------------------------|----|-------------------------------|----|--------------------------|----|---------------|----|-----------------------|----|--------------------------|----|---------------|----|----------------|----|
|          | cm                              | in | cm                            | in | cm                       | in | cm            | in | cm                    | in | cm                       | in | cm            | in | cm             | in |
| <b>A</b> | 198                             | 78 | 112                           | 45 | 172                      | 68 | 106           | 42 | 87                    | 35 | 106                      | 42 | 151           | 60 | 107            | 43 |
| <b>B</b> | 106                             | 42 | 106                           | 42 | 106                      | 42 | 106           | 42 | 106                   | 42 | 170                      | 67 | 107           | 43 | 107            | 43 |
| <b>C</b> | 80                              | 32 | 80                            | 32 | 80                       | 32 | 80            | 32 | 80                    | 32 | 80                       | 32 | 42            | 17 | 42             | 17 |

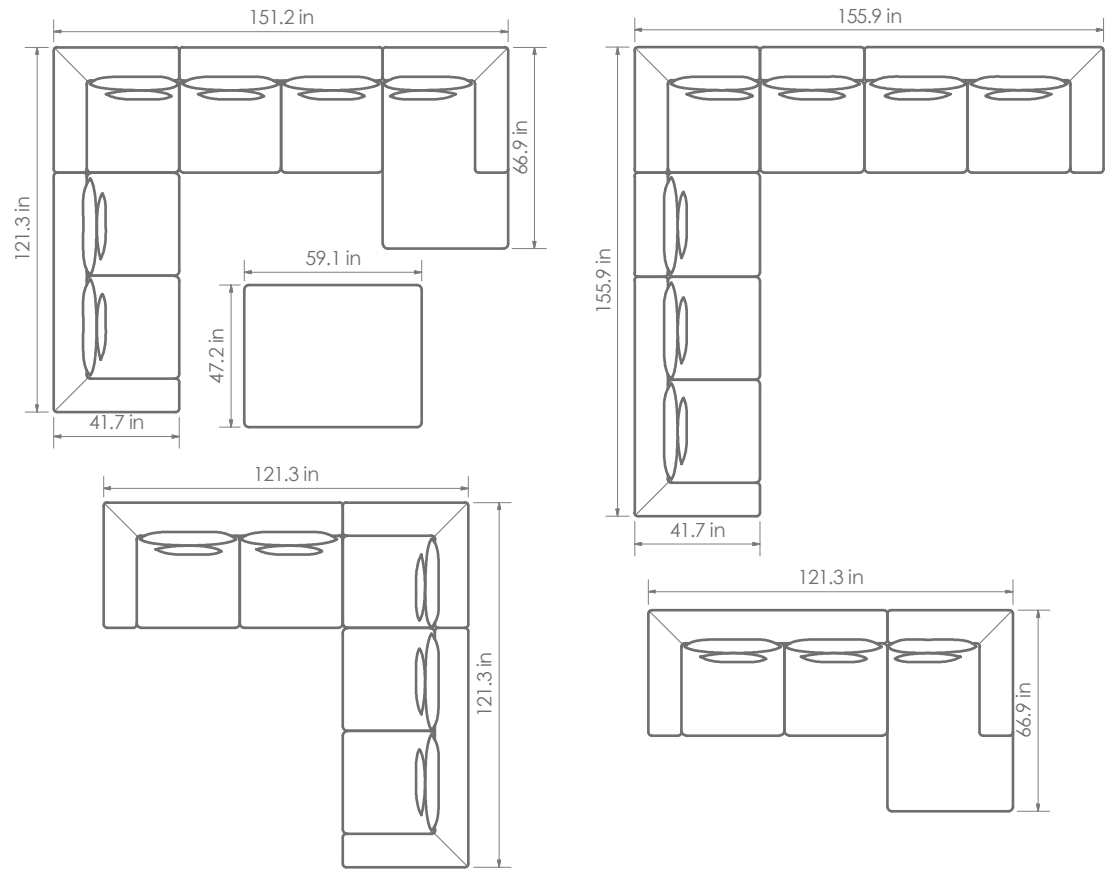
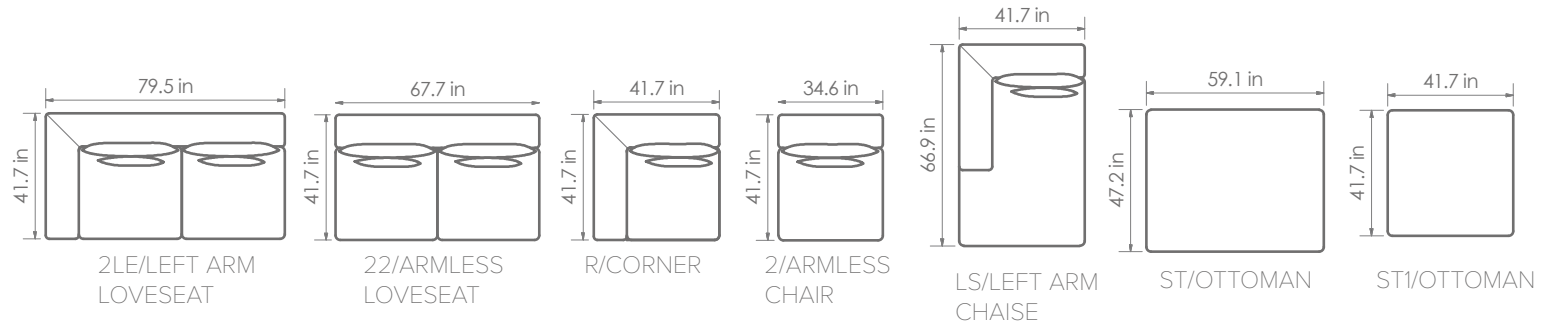

# COLORADO

MX2140

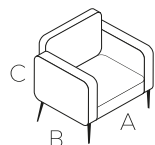

|   | (3D) SOFÁ |    | (2D) LOVESEAT |    | (1D) SILLÓN |    |
|---|-----------|----|---------------|----|-------------|----|
|   | cm        | in | cm            | in | cm          | in |
| A | 229       | 91 | 179           | 71 | 103         | 41 |
| B | 100       | 40 | 100           | 40 | 100         | 40 |
| C | 81        | 32 | 81            | 32 | 81          | 32 |



# BELLAGIO

MX2160

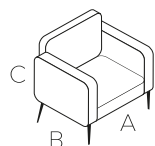

(2LE/2RE) LOVESEAT  
CON BRAZO

|          | cm  | in |
|----------|-----|----|
| <b>A</b> | 215 | 85 |
| <b>B</b> | 98  | 39 |
| <b>C</b> | 83  | 33 |

(LS/RS) CHAISE CON BRAZO

|  | cm  | in |
|--|-----|----|
|  | 96  | 38 |
|  | 219 | 87 |
|  | 83  | 33 |

(3D) SOFÁ

|  | cm  | in |
|--|-----|----|
|  | 246 | 97 |
|  | 98  | 39 |
|  | 83  | 33 |

(2D) LOVESEAT

|  | cm  | in |
|--|-----|----|
|  | 201 | 80 |
|  | 98  | 39 |
|  | 83  | 33 |

(1D) SILLÓN

|  | cm  | in |
|--|-----|----|
|  | 144 | 57 |
|  | 98  | 39 |
|  | 83  | 33 |

# BELLAGIO

MX2160

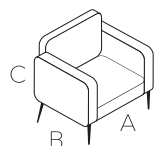

(2LE/2RE) LOVESEAT  
CON BRAZO

|          | cm  | in |
|----------|-----|----|
| <b>A</b> | 215 | 85 |
| <b>B</b> | 98  | 39 |
| <b>C</b> | 83  | 33 |

(LS/RS) CHAISE CON BRAZO

|          | cm  | in |
|----------|-----|----|
| <b>A</b> | 96  | 38 |
| <b>B</b> | 219 | 87 |
| <b>C</b> | 83  | 33 |

(3D) SOFÁ

|          | cm  | in |
|----------|-----|----|
| <b>A</b> | 246 | 97 |
| <b>B</b> | 98  | 39 |
| <b>C</b> | 83  | 33 |

(2D) LOVESEAT

|          | cm  | in |
|----------|-----|----|
| <b>A</b> | 201 | 80 |
| <b>B</b> | 98  | 39 |
| <b>C</b> | 83  | 33 |

(1D) SILLÓN

|          | cm  | in |
|----------|-----|----|
| <b>A</b> | 144 | 57 |
| <b>B</b> | 98  | 39 |
| <b>C</b> | 83  | 33 |

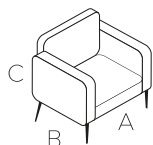

(2LE/2RE) LOVESEAT  
CON BRAZO

|          | cm  | in |
|----------|-----|----|
| <b>A</b> | 215 | 85 |
| <b>B</b> | 98  | 39 |
| <b>C</b> | 83  | 33 |

(LS/RS) CHAISE CON BRAZO

|          | cm  | in |
|----------|-----|----|
| <b>A</b> | 96  | 38 |
| <b>B</b> | 219 | 87 |
| <b>C</b> | 83  | 33 |

(3D) SOFÁ

|          | cm  | in |
|----------|-----|----|
| <b>A</b> | 246 | 97 |
| <b>B</b> | 98  | 39 |
| <b>C</b> | 83  | 33 |

(2D) LOVESEAT

|          | cm  | in |
|----------|-----|----|
| <b>A</b> | 201 | 80 |
| <b>B</b> | 98  | 39 |
| <b>C</b> | 83  | 33 |

(1D) SILLÓN

|          | cm  | in |
|----------|-----|----|
| <b>A</b> | 144 | 57 |
| <b>B</b> | 98  | 39 |
| <b>C</b> | 83  | 33 |

# ANDIAMO

MX2170

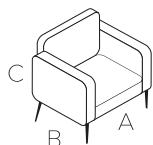

|          | (3D) SOFÁ |    | (2D) LOVESEAT |    | (1D) SILLÓN |    |
|----------|-----------|----|---------------|----|-------------|----|
|          | cm        | in | cm            | in | cm          | in |
| <b>A</b> | 238       | 94 | 196           | 78 | 142         | 56 |
| <b>B</b> | 101       | 40 | 101           | 40 | 101         | 40 |
| <b>C</b> | 87        | 35 | 87            | 35 | 87          | 35 |

# AVIGNON

MX2210

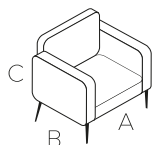

|   | (3D) SOFÁ |    | (2D) LOVESEAT |    | (1D) SILLÓN |    |
|---|-----------|----|---------------|----|-------------|----|
|   | cm        | in | cm            | in | cm          | in |
| A | 227       | 90 | 177           | 70 | 112         | 45 |
| B | 100       | 40 | 100           | 40 | 100         | 40 |
| C | 88        | 35 | 88            | 35 | 88          | 35 |

# ROMA

# MX2230

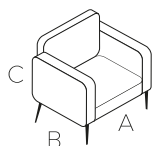

|          | (2LE/2RE) LOVESEAT CON BRAZO |    | (R) ESQUINERO |    | (2S) LOVESEAT SIN BRAZOS |    | (LS/RS) CHAISE CON BRAZO |    | (ST) TABURETE |    | (ST1) TABURETE |    | (3D) SOFÁ |     | (2D) LOVESEAT |    |
|----------|------------------------------|----|---------------|----|--------------------------|----|--------------------------|----|---------------|----|----------------|----|-----------|-----|---------------|----|
|          | cm                           | in | cm            | in | cm                       | in | cm                       | in | cm            | in | cm             | in | cm        | in  | cm            | in |
| <b>A</b> | 198                          | 78 | 106           | 42 | 172                      | 68 | 106                      | 42 | 151           | 60 | 107            | 43 | 264       | 104 | 194           | 77 |
| <b>B</b> | 106                          | 42 | 106           | 42 | 106                      | 42 | 170                      | 67 | 107           | 43 | 107            | 43 | 106       | 42  | 106           | 42 |
| <b>C</b> | 80                           | 32 | 80            | 32 | 80                       | 32 | 80                       | 32 | 42            | 17 | 42             | 17 | 80        | 32  | 80            | 32 |

# ROMA

# MX2230

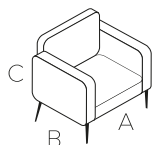

|          | (2LE/2RE) LOVESEAT CON BRAZO |    | (R) ESQUINERO |    | (2S) LOVESEAT SIN BRAZOS |    | (LS/RS) CHAISE CON BRAZO |    | (ST) TABURETE |    | (ST1) TABURETE |    | (3D) SOFÁ |     | (2D) LOVESEAT |    |
|----------|------------------------------|----|---------------|----|--------------------------|----|--------------------------|----|---------------|----|----------------|----|-----------|-----|---------------|----|
|          | cm                           | in | cm            | in | cm                       | in | cm                       | in | cm            | in | cm             | in | cm        | in  | cm            | in |
| <b>A</b> | 198                          | 78 | 106           | 42 | 172                      | 68 | 106                      | 42 | 151           | 60 | 107            | 43 | 264       | 104 | 194           | 77 |
| <b>B</b> | 106                          | 42 | 106           | 42 | 106                      | 42 | 170                      | 67 | 107           | 43 | 107            | 43 | 106       | 42  | 106           | 42 |
| <b>C</b> | 80                           | 32 | 80            | 32 | 80                       | 32 | 80                       | 32 | 42            | 17 | 42             | 17 | 80        | 32  | 80            | 32 |

# ARIZONA

MX2240

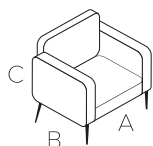

|          | (R) ESQUINERO |    | (S) SILLON SIN BRAZOS |    | (ST) TABURETE |    |
|----------|---------------|----|-----------------------|----|---------------|----|
|          | cm            | in | cm                    | in | cm            | in |
| <b>A</b> | 88            | 35 | 88                    | 35 | 88            | 35 |
| <b>B</b> | 88            | 35 | 88                    | 35 | 88            | 35 |
| <b>C</b> | 79            | 32 | 79                    | 32 | 45            | 18 |



# MIAMI

# MX2250

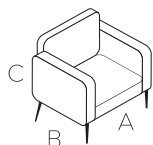

(2LE/2RE) LOVESEAT  
CON BRAZO

cm in

|          |     |    |
|----------|-----|----|
| <b>A</b> | 176 | 70 |
| <b>B</b> | 103 | 41 |
| <b>C</b> | 81  | 32 |

(LS/RS) CHAISE CON BRAZO

cm in

|  |     |    |
|--|-----|----|
|  | 182 | 72 |
|  | 102 | 41 |
|  | 81  | 32 |

# MIAMI

# MX2250

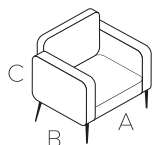

(2LE/2RE) LOVESEAT  
CON BRAZO

cm in

|          |     |    |
|----------|-----|----|
| <b>A</b> | 176 | 70 |
| <b>B</b> | 103 | 41 |
| <b>C</b> | 81  | 32 |

(LS/RS) CHAISE CON BRAZO

cm in

|  |     |    |
|--|-----|----|
|  | 182 | 72 |
|  | 102 | 41 |
|  | 81  | 32 |

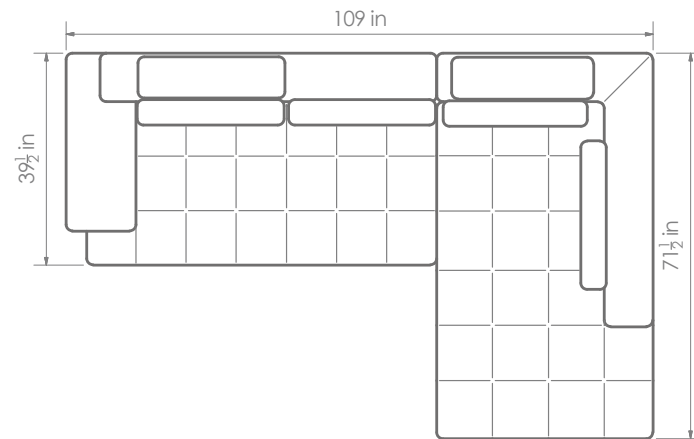
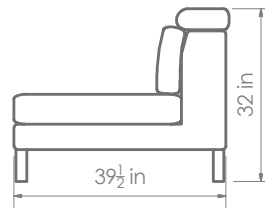
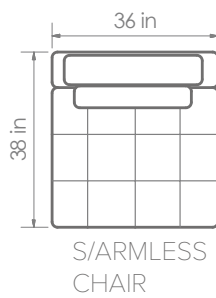
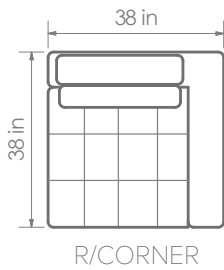
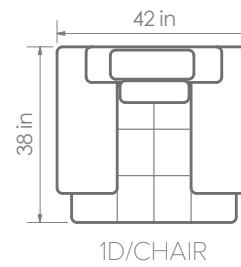
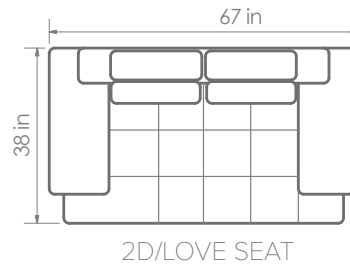
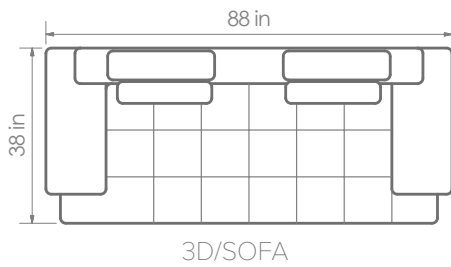
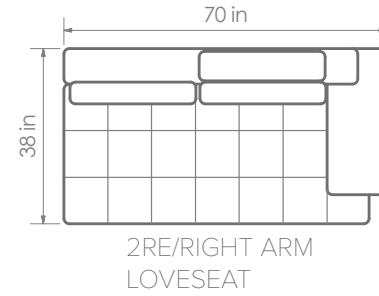
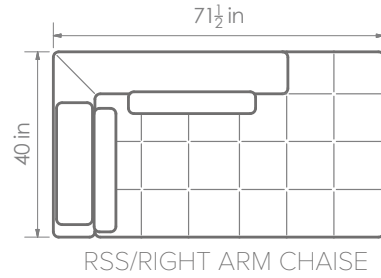
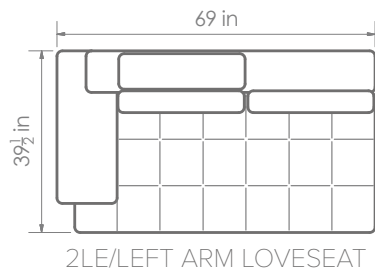



|          | (2LE/2RE) LOVESEAT CON BRAZO |    | (2S) LOVESEAT SIN BRAZOS |    | (R) ESQUINERO |    | (S) SILLON SIN BRAZOS |    | (LS/RS) CHAISE CON BRAZO |    | (ST) TABURETE |    | (3D) SOFÁ |    | (2D) LOVESEAT |    | (1D) SILLÓN |    |
|----------|------------------------------|----|--------------------------|----|---------------|----|-----------------------|----|--------------------------|----|---------------|----|-----------|----|---------------|----|-------------|----|
|          | cm                           | in | cm                       | in | cm            | in | cm                    | in | cm                       | in | cm            | in | cm        | in | cm            | in | cm          | in |
| <b>A</b> | 188                          | 75 | 154                      | 61 | 100           | 40 | 77                    | 31 | 98                       | 39 | 154           | 61 | 247       | 98 | 195           | 77 | 145         | 57 |
| <b>B</b> | 100                          | 40 | 100                      | 40 | 100           | 40 | 100                   | 40 | 178                      | 71 | 76            | 30 | 100       | 40 | 100           | 40 | 100         | 39 |
| <b>C</b> | 87                           | 35 | 74                       | 30 | 74            | 30 | 74                    | 30 | 87                       | 35 | 44            | 18 | 87        | 35 | 87            | 35 | 87          | 34 |



|          | (2LE/2RE) LOVESEAT CON BRAZO |    | (2S) LOVESEAT SIN BRAZOS |    | (R) ESQUINERO |    | (S) SILLON SIN BRAZOS |    | (LS/RS) CHAISE CON BRAZO |    | (ST) TABURETE |    | (3D) SOFÁ |    | (2D) LOVESEAT |    | (1D) SILLÓN |    |
|----------|------------------------------|----|--------------------------|----|---------------|----|-----------------------|----|--------------------------|----|---------------|----|-----------|----|---------------|----|-------------|----|
|          | cm                           | in | cm                       | in | cm            | in | cm                    | in | cm                       | in | cm            | in | cm        | in | cm            | in | cm          | in |
| <b>A</b> | 188                          | 75 | 154                      | 61 | 100           | 40 | 77                    | 31 | 98                       | 39 | 154           | 61 | 247       | 98 | 195           | 77 | 145         | 57 |
| <b>B</b> | 100                          | 40 | 100                      | 40 | 100           | 40 | 100                   | 40 | 178                      | 71 | 76            | 30 | 100       | 40 | 100           | 40 | 100         | 39 |
| <b>C</b> | 87                           | 35 | 74                       | 30 | 74            | 30 | 74                    | 30 | 87                       | 35 | 44            | 18 | 87        | 35 | 87            | 35 | 87          | 34 |



(2LE/2RE) LOVESEAT  
CON BRAZO

(2S) LOVESEAT SIN BRAZOS

(R) ESQUINERO

(S) SILLON SIN BRAZOS

(LS/RS) CHAISE CON BRAZO

(ST) TABURETE

(3D) SOFÁ

(2D) LOVESEAT

(1D) SILLÓN

|          | cm  | in | cm  | in | cm  | in | cm  | in | cm  | in | cm  | in | cm  | in | cm  | in | cm  | in |
|----------|-----|----|-----|----|-----|----|-----|----|-----|----|-----|----|-----|----|-----|----|-----|----|
| <b>A</b> | 188 | 75 | 154 | 61 | 100 | 40 | 77  | 31 | 98  | 39 | 154 | 61 | 247 | 98 | 195 | 77 | 145 | 57 |
| <b>B</b> | 100 | 40 | 100 | 40 | 100 | 40 | 100 | 40 | 178 | 71 | 76  | 30 | 100 | 40 | 100 | 40 | 100 | 39 |
| <b>C</b> | 87  | 35 | 74  | 30 | 74  | 30 | 74  | 30 | 87  | 35 | 44  | 18 | 87  | 35 | 87  | 35 | 87  | 34 |

ITALIA

MX2260



|          | (2LE/2RE) LOVESEAT CON BRAZO |    | (2S) LOVESEAT SIN BRAZOS |    | (R) ESQUINERO |    | (S) SILLON SIN BRAZOS |    | (LS/RS) CHAISE CON BRAZO |    | (ST) TABURETE |    | (3D) SOFÁ |    | (2D) LOVESEAT |    | (1D) SILLÓN |    |
|----------|------------------------------|----|--------------------------|----|---------------|----|-----------------------|----|--------------------------|----|---------------|----|-----------|----|---------------|----|-------------|----|
|          | cm                           | in | cm                       | in | cm            | in | cm                    | in | cm                       | in | cm            | in | cm        | in | cm            | in | cm          | in |
| <b>A</b> | 188                          | 75 | 154                      | 61 | 100           | 40 | 77                    | 31 | 98                       | 39 | 154           | 61 | 247       | 98 | 195           | 77 | 145         | 57 |
| <b>B</b> | 100                          | 40 | 100                      | 40 | 100           | 40 | 100                   | 40 | 178                      | 71 | 76            | 30 | 100       | 40 | 100           | 40 | 100         | 39 |
| <b>C</b> | 87                           | 35 | 74                       | 30 | 74            | 30 | 74                    | 30 | 87                       | 35 | 44            | 18 | 87        | 35 | 87            | 35 | 87          | 34 |

# ITALIA

# MX2260



|          | (2LE/2RE) LOVESEAT CON BRAZO |    | (2S) LOVESEAT SIN BRAZOS |    | (R) ESQUINERO |    | (S) SILLON SIN BRAZOS |    | (LS/RS) CHAISE CON BRAZO |    | (ST) TABURETE |    | (3D) SOFÁ |    | (2D) LOVESEAT |    | (1D) SILLÓN |    |
|----------|------------------------------|----|--------------------------|----|---------------|----|-----------------------|----|--------------------------|----|---------------|----|-----------|----|---------------|----|-------------|----|
|          | cm                           | in | cm                       | in | cm            | in | cm                    | in | cm                       | in | cm            | in | cm        | in | cm            | in | cm          | in |
| <b>A</b> | 188                          | 75 | 154                      | 61 | 100           | 40 | 77                    | 31 | 98                       | 39 | 154           | 61 | 247       | 98 | 195           | 77 | 145         | 57 |
| <b>B</b> | 100                          | 40 | 100                      | 40 | 100           | 40 | 100                   | 40 | 178                      | 71 | 76            | 30 | 100       | 40 | 100           | 40 | 100         | 39 |
| <b>C</b> | 87                           | 35 | 74                       | 30 | 74            | 30 | 74                    | 30 | 87                       | 35 | 44            | 18 | 87        | 35 | 87            | 35 | 87          | 34 |



ITALIA

MX2261



|          | (2LE/2RE) LOVESEAT CON BRAZO |    | (2S) LOVESEAT SIN BRAZOS |    | (R) ESQUINERO |    | (S) SILLON SIN BRAZOS |    | (LS/RS) CHAISE CON BRAZO |    | (ST) TABURETE |    | (3D) SOFÁ |    | (2D) LOVESEAT |    | (1D) SILLÓN |    |
|----------|------------------------------|----|--------------------------|----|---------------|----|-----------------------|----|--------------------------|----|---------------|----|-----------|----|---------------|----|-------------|----|
|          | cm                           | in | cm                       | in | cm            | in | cm                    | in | cm                       | in | cm            | in | cm        | in | cm            | in | cm          | in |
| <b>A</b> | 188                          | 75 | 154                      | 61 | 100           | 40 | 77                    | 31 | 98                       | 39 | 154           | 61 | 247       | 98 | 195           | 77 | 145         | 57 |
| <b>B</b> | 100                          | 40 | 100                      | 40 | 100           | 40 | 100                   | 40 | 178                      | 71 | 76            | 30 | 100       | 40 | 100           | 40 | 100         | 39 |
| <b>C</b> | 87                           | 35 | 74                       | 30 | 74            | 30 | 74                    | 30 | 87                       | 35 | 44            | 18 | 87        | 35 | 87            | 35 | 87          | 34 |

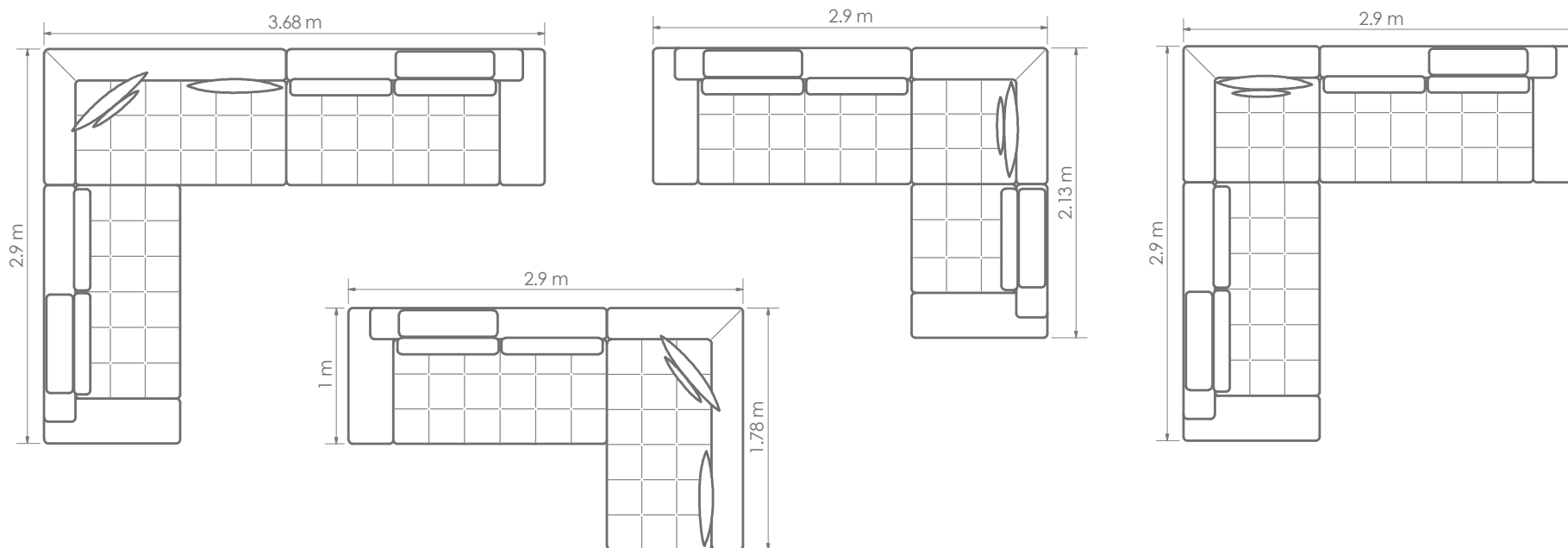
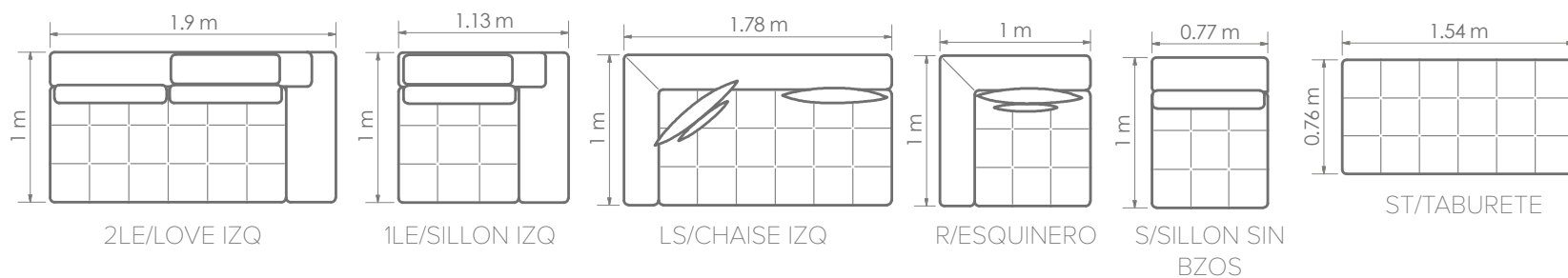

# AUSTIN

MX2280

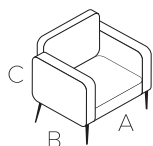

|          | (1LE/1RE) SILLÓN<br>CON BRAZO |    | (RLE/RRE) ESQUINERO<br>CON BRAZO |    | (S) SILLON SIN BRAZOS |    | (ST) TABURETE |    |
|----------|-------------------------------|----|----------------------------------|----|-----------------------|----|---------------|----|
|          | cm                            | in | cm                               | in | cm                    | in | cm            | in |
| <b>A</b> | 110                           | 44 | 119                              | 47 | 87                    | 35 | 87            | 35 |
| <b>B</b> | 89                            | 36 | 89                               | 36 | 89                    | 36 | 87            | 35 |
| <b>C</b> | 80                            | 32 | 80                               | 32 | 80                    | 32 | 45            | 18 |



AUSTIN

MX2280

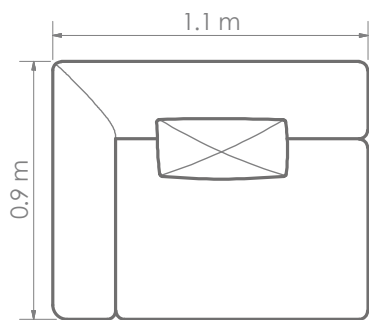

1RE/SILLON DER

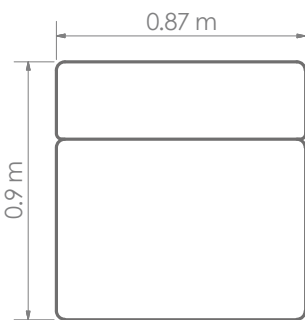

S/SILLON S/BZOS

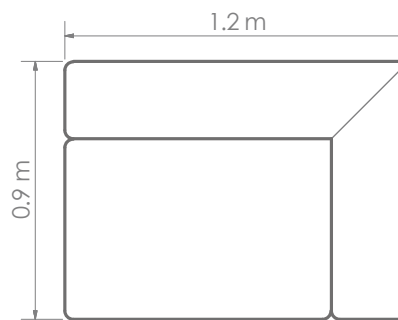

RLE/ESQ IZQ

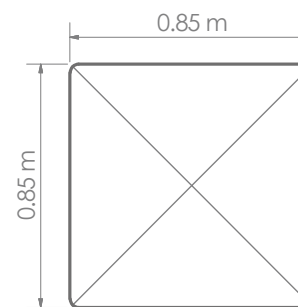

ST/TABURETE

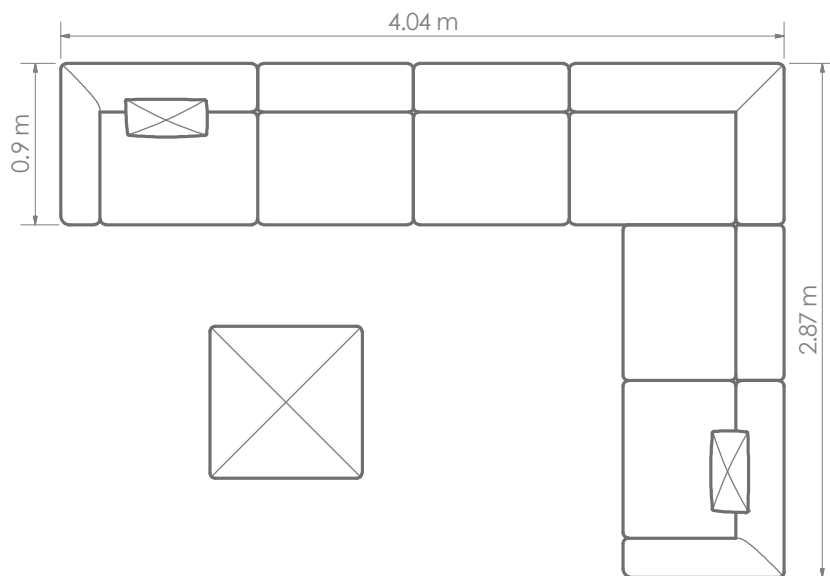













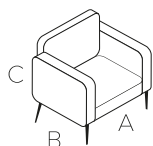

|          | (2LE/2RE) LOVESEAT<br>CON BRAZO |    | (1LE/1RE) SILLÓN<br>CON BRAZO |    | (2S) LOVESEAT SIN BRAZOS |    | (R) ESQUINERO |    | (S) SILLÓN SIN BRAZOS |    | (LS/RS) CHAISE CON BRAZO |    | (ST1) TABURETE |    | (ST1) TABURETE |    |
|----------|---------------------------------|----|-------------------------------|----|--------------------------|----|---------------|----|-----------------------|----|--------------------------|----|----------------|----|----------------|----|
|          | cm                              | in | cm                            | in | cm                       | in | cm            | in | cm                    | in | cm                       | in | cm             | in | cm             | in |
| <b>A</b> | 199                             | 79 | 113                           | 45 | 172                      | 68 | 106           | 42 | 87                    | 35 | 105                      | 42 | 151            | 42 | 106            | 42 |
| <b>B</b> | 106                             | 42 | 106                           | 42 | 106                      | 42 | 106           | 42 | 106                   | 42 | 170                      | 67 | 106            | 42 | 106            | 42 |
| <b>C</b> | 83                              | 33 | 83                            | 33 | 83                       | 33 | 83            | 33 | 83                    | 33 | 83                       | 33 | 40             | 16 | 40             | 16 |

# MONACO

MX2321

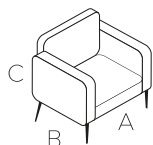

|          | (2LE/2RE) LOVESEAT CON BRAZO |    | (1LE/1RE) SILLÓN CON BRAZO |    | (2S) LOVESEAT SIN BRAZOS |    | (R) ESQUINERO |    | (S) SILLON SIN BRAZOS |    | (LS/RS) CHAISE CON BRAZO |    | (ST1) TABURETE |    | (ST1) TABURETE |    |
|----------|------------------------------|----|----------------------------|----|--------------------------|----|---------------|----|-----------------------|----|--------------------------|----|----------------|----|----------------|----|
|          | cm                           | in | cm                         | in | cm                       | in | cm            | in | cm                    | in | cm                       | in | cm             | in | cm             | in |
| <b>A</b> | 199                          | 79 | 113                        | 45 | 172                      | 68 | 106           | 42 | 87                    | 35 | 105                      | 42 | 151            | 42 | 106            | 42 |
| <b>B</b> | 106                          | 42 | 106                        | 42 | 106                      | 42 | 106           | 42 | 106                   | 42 | 170                      | 67 | 106            | 42 | 106            | 42 |
| <b>C</b> | 83                           | 33 | 83                         | 33 | 83                       | 33 | 83            | 33 | 83                    | 33 | 83                       | 33 | 40             | 16 | 40             | 16 |

# DENVER

# MX2350

\* Pillows and accesories sold separately.  
Accesorios y cojines se venden por separado

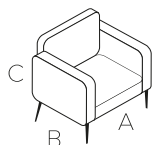

(2LE/2RE) LOVESEAT CON BRAZO

|          | cm  | in |
|----------|-----|----|
| <b>A</b> | 172 | 68 |
| <b>B</b> | 100 | 40 |
| <b>C</b> | 90  | 36 |

(LS/RS) CHAISE CON BRAZO

|          | cm  | in |
|----------|-----|----|
| <b>A</b> | 99  | 39 |
| <b>B</b> | 168 | 67 |
| <b>C</b> | 90  | 36 |

CLEO

MX2370

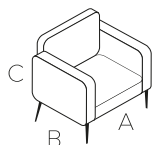

|          | (2LE/2RE) LOVESEAT CON BRAZO |    | (2S) LOVESEAT SIN BRAZOS |    | (R) ESQUINERO |    | (LS/RS) CHAISE CON BRAZO |    | (ST) TABURETE |    |
|----------|------------------------------|----|--------------------------|----|---------------|----|--------------------------|----|---------------|----|
|          | cm                           | in | cm                       | in | cm            | in | cm                       | in | cm            | in |
| <b>A</b> | 181                          | 72 | 161                      | 64 | 92            | 37 | 100                      | 40 | 176           | 70 |
| <b>B</b> | 92                           | 37 | 92                       | 37 | 92            | 37 | 180                      | 71 | 74            | 30 |
| <b>C</b> | 75                           | 30 | 75                       | 30 | 75            | 30 | 75                       | 30 | 44            | 18 |

# CLEO

MX2370

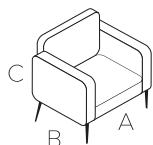

|          | (2LE/2RE) LOVESEAT CON BRAZO |    | (2S) LOVESEAT SIN BRAZOS |    | (R) ESQUINERO |    | (LS/RS) CHAISE CON BRAZO |    | (ST) TABURETE |    |
|----------|------------------------------|----|--------------------------|----|---------------|----|--------------------------|----|---------------|----|
|          | cm                           | in | cm                       | in | cm            | in | cm                       | in | cm            | in |
| <b>A</b> | 181                          | 72 | 161                      | 64 | 92            | 37 | 100                      | 40 | 176           | 70 |
| <b>B</b> | 92                           | 37 | 92                       | 37 | 92            | 37 | 180                      | 71 | 74            | 30 |
| <b>C</b> | 75                           | 30 | 75                       | 30 | 75            | 30 | 75                       | 30 | 44            | 18 |

# NORWAY

MX2410

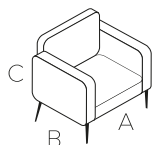

| (2LE/2RE) LOVESEAT CON BRAZO |     | (1LE/1RE) SILLÓN CON BRAZO |     | (2S) LOVESEAT SIN BRAZOS |     | (R) ESQUINERO |     | (S) SILLON SIN BRAZOS |    |    |
|------------------------------|-----|----------------------------|-----|--------------------------|-----|---------------|-----|-----------------------|----|----|
| cm                           | in  | cm                         | in  | cm                       | in  | cm            | in  | cm                    | in |    |
| <b>A</b>                     | 181 | 72                         | 101 | 40                       | 162 | 64            | 117 | 47                    | 82 | 33 |
| <b>B</b>                     | 91  | 36                         | 91  | 36                       | 91  | 36            | 117 | 47                    | 91 | 36 |
| <b>C</b>                     | 84  | 34                         | 84  | 34                       | 84  | 34            | 84  | 34                    | 84 | 34 |

# ASPEN

MX2420

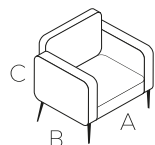

|          | (2LE/2RE) LOVESEAT CON BRAZO |    | (LS/RS) CHAISE CON BRAZO |    |
|----------|------------------------------|----|--------------------------|----|
|          | cm                           | in | cm                       | in |
| <b>A</b> | 136                          | 54 | 90                       | 36 |
| <b>B</b> | 97                           | 39 | 166                      | 66 |
| <b>C</b> | 81                           | 32 | 81                       | 32 |



# ASPEN

# MX2420

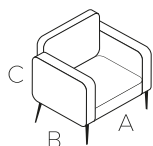

|          | (2LE/2RE) LOVESEAT CON BRAZO |    | (LS/RS) CHAISE CON BRAZO |    |
|----------|------------------------------|----|--------------------------|----|
|          | cm                           | in | cm                       | in |
| <b>A</b> | 136                          | 54 | 90                       | 36 |
| <b>B</b> | 97                           | 39 | 166                      | 66 |
| <b>C</b> | 81                           | 32 | 81                       | 32 |

# ASPEN

MX2420

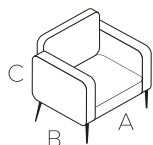

|          | (2LE/2RE) LOVESEAT CON BRAZO |    | (LS/RS) CHAISE CON BRAZO |    |
|----------|------------------------------|----|--------------------------|----|
|          | cm                           | in | cm                       | in |
| <b>A</b> | 136                          | 54 | 90                       | 36 |
| <b>B</b> | 97                           | 39 | 166                      | 66 |
| <b>C</b> | 81                           | 32 | 81                       | 32 |

# VIENNA

MX2430

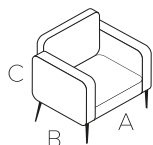

|          | (2S) LOVESEAT SIN BRAZOS |    | (R) ESQUINERO |    | (S) SILLON SIN BRAZOS |    | (ST) TABURETE |    |
|----------|--------------------------|----|---------------|----|-----------------------|----|---------------|----|
|          | cm                       | in | cm            | in | cm                    | in | cm            | in |
| <b>A</b> | 160                      | 63 | 99            | 39 | 80                    | 32 | 99            | 39 |
| <b>B</b> | 99                       | 39 | 99            | 39 | 99                    | 39 | 80            | 32 |
| <b>C</b> | 86                       | 34 | 86            | 34 | 86                    | 34 | 46            | 19 |

# VIENNA

MX2430

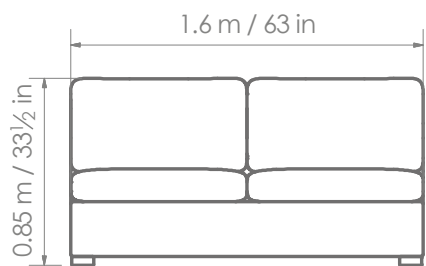

2S/LOVESEAT SIN BZOS

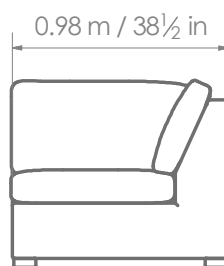

R/ESQUINERO

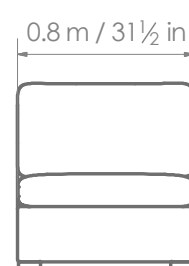

S/SILLON  
SIN/BZOS

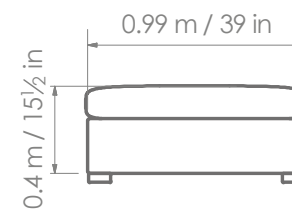

ST/TABURETE

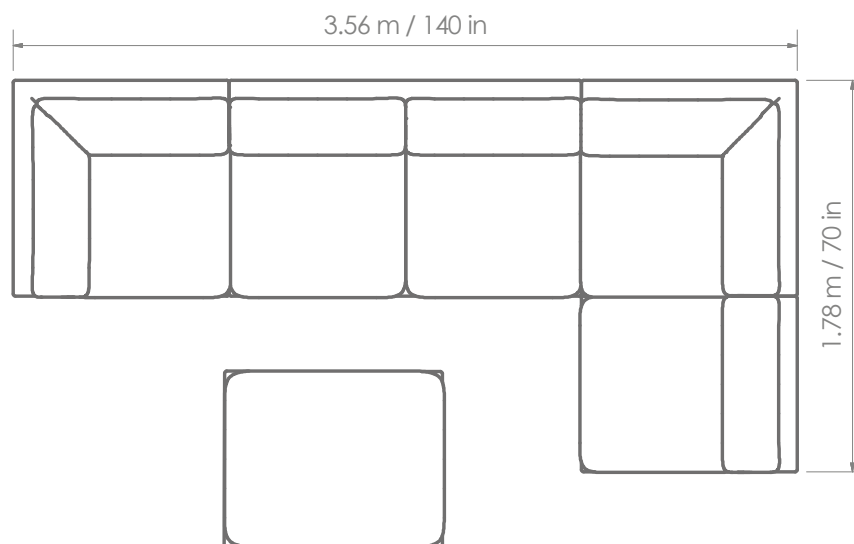
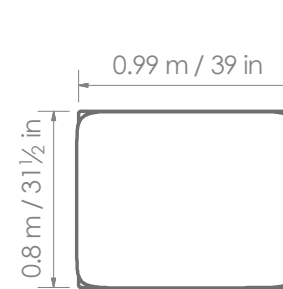
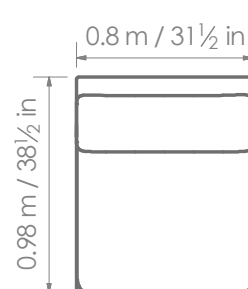
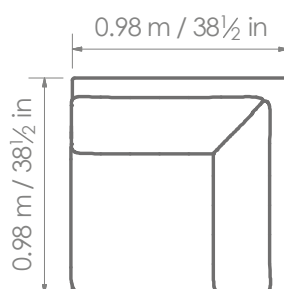
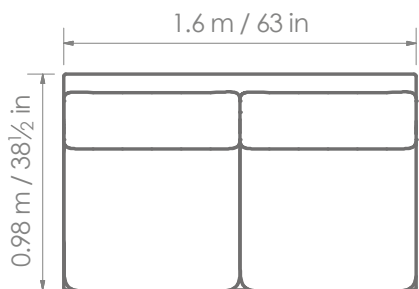

# MARSEILLE

MX2440

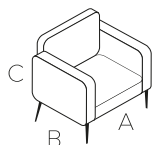

|          | (1L/1R) SILLÓN<br>CON BRAZO |    | (R) ESQUINERO |    | (S) SILLÓN SIN BRAZOS |    | (ST) TABURETE |    |
|----------|-----------------------------|----|---------------|----|-----------------------|----|---------------|----|
|          | cm                          | in | cm            | in | cm                    | in | cm            | in |
| <b>A</b> | 72                          | 29 | 82            | 33 | 62                    | 25 | 82            | 33 |
| <b>B</b> | 82                          | 33 | 82            | 33 | 82                    | 33 | 62            | 25 |
| <b>C</b> | 83                          | 33 | 83            | 33 | 83                    | 33 | 45            | 18 |

# MARSEILLE

MX2440

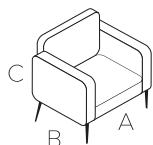

|          | (1L/1R) SILLÓN<br>CON BRAZO |    | (R) ESQUINERO |    | (S) SILLÓN SIN BRAZOS |    | (ST) TABURETE |    |
|----------|-----------------------------|----|---------------|----|-----------------------|----|---------------|----|
|          | cm                          | in | cm            | in | cm                    | in | cm            | in |
| <b>A</b> | 72                          | 29 | 82            | 33 | 62                    | 25 | 82            | 33 |
| <b>B</b> | 82                          | 33 | 82            | 33 | 82                    | 33 | 62            | 25 |
| <b>C</b> | 83                          | 33 | 83            | 33 | 83                    | 33 | 45            | 18 |

# MARSEILLE

MX2440

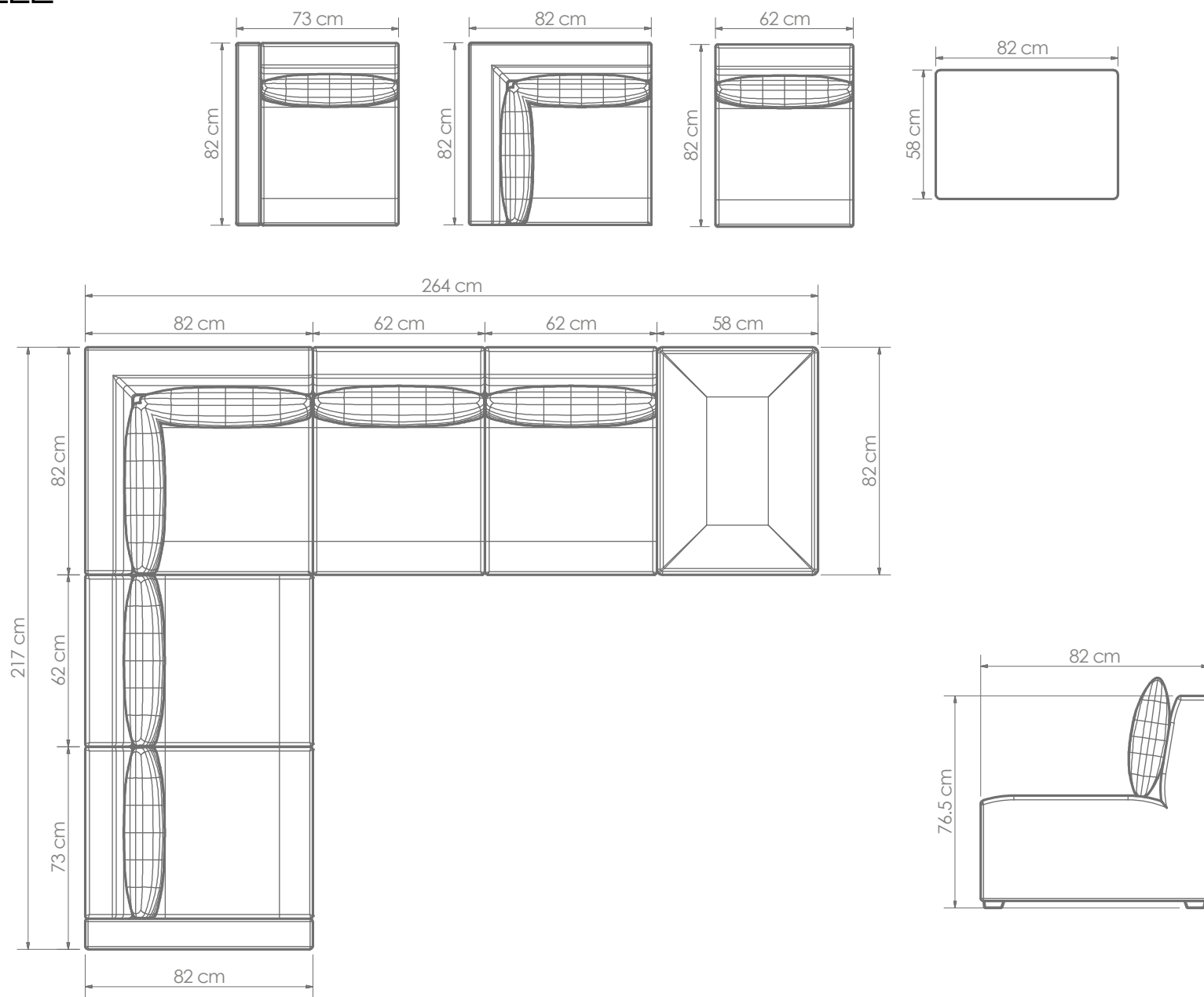

PORTLAND

---

MX2460

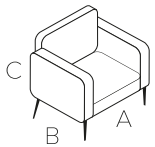



FLORIDA

MX2470

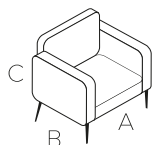

LYON

MX2480

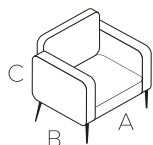

|   | (3D) SOFÁ |    | (2D) LOVESEAT |    | (1D) SILLÓN |    |
|---|-----------|----|---------------|----|-------------|----|
|   | cm        | in | cm            | in | cm          | in |
| A | 211       | 84 | 161           | 64 | 96          | 38 |
| B | 100       | 40 | 100           | 40 | 100         | 40 |
| C | 87        | 35 | 87            | 35 | 87          | 35 |

LYON

MX2480

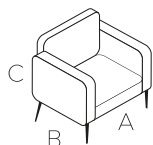

|          | (3D) SOFÁ |    | (2D) LOVESEAT |    | (1D) SILLÓN |    |
|----------|-----------|----|---------------|----|-------------|----|
|          | cm        | in | cm            | in | cm          | in |
| <b>A</b> | 211       | 84 | 161           | 64 | 96          | 38 |
| <b>B</b> | 100       | 40 | 100           | 40 | 100         | 40 |
| <b>C</b> | 87        | 35 | 87            | 35 | 87          | 35 |

# PROVENZA

MX2490

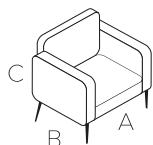

|          | (2LE/2RE) LOVESEAT<br>CON BRAZO |    | (LS/RS) CHAISE CON BRAZO |    | (R) ESQUINERO |    | (S) SILLON SIN BRAZOS |    | (ST) TABURETE |    |
|----------|---------------------------------|----|--------------------------|----|---------------|----|-----------------------|----|---------------|----|
|          | cm                              | in | cm                       | in | cm            | in | cm                    | in | cm            | in |
| <b>A</b> | 180                             | 71 | 100                      | 40 | 104           | 41 | 104                   | 41 | 104           | 41 |
| <b>B</b> | 104                             | 41 | 180                      | 71 | 104           | 41 | 104                   | 41 | 104           | 41 |
| <b>C</b> | 93                              | 37 | 93                       | 37 | 93            | 37 | 93                    | 37 | 44            | 18 |

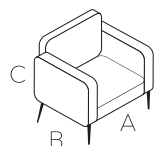

|          | (2LE/2RE) LOVESEAT<br>CON BRAZO |    | (LS/RS) CHAISE CON BRAZO |    | (R) ESQUINERO |    | (S) SILLON SIN BRAZOS |    | (ST) TABURETE |    |
|----------|---------------------------------|----|--------------------------|----|---------------|----|-----------------------|----|---------------|----|
|          | cm                              | in | cm                       | in | cm            | in | cm                    | in | cm            | in |
| <b>A</b> | 180                             | 71 | 100                      | 40 | 104           | 41 | 104                   | 41 | 104           | 41 |
| <b>B</b> | 104                             | 41 | 180                      | 71 | 104           | 41 | 104                   | 41 | 104           | 41 |
| <b>C</b> | 93                              | 37 | 93                       | 37 | 93            | 37 | 93                    | 37 | 44            | 18 |

MOHAB

---

MX2510

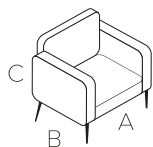

# CRIMSON

MX2530

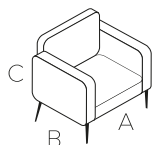

|          | (3D) SOFÁ |    | (2D) LOVESEAT |    | (1D) SILLÓN |    |
|----------|-----------|----|---------------|----|-------------|----|
|          | cm        | in | cm            | in | cm          | in |
| <b>A</b> | 223       | 88 | 163           | 65 | 108         | 43 |
| <b>B</b> | 106       | 42 | 106           | 42 | 106         | 42 |
| <b>C</b> | 95        | 38 | 95            | 38 | 95          | 38 |

# CIRRUS

# MX2560



|          | (2LE/2RE) LOVESEAT<br>CON BRAZO |    | (1LE/1RE) SILLÓN<br>CON BRAZO |    | (2S) LOVESEAT SIN<br>BRAZOS |    | (R) ESQUINERO |    | (S) SILLON SIN BRAZOS |    | (LS/RS) CHAISE CON<br>BRAZO |    | (ST) TABURETE |    | (3D) SOFÁ |    | (2D) LOVESEAT |    | (1D) SILLÓN |    |
|----------|---------------------------------|----|-------------------------------|----|-----------------------------|----|---------------|----|-----------------------|----|-----------------------------|----|---------------|----|-----------|----|---------------|----|-------------|----|
|          | cm                              | in | cm                            | in | cm                          | in | cm            | in | cm                    | in | cm                          | in | cm            | in | cm        | in | cm            | in | cm          | in |
| <b>A</b> | 200                             | 79 | 111                           | 44 | 180                         | 71 | 105           | 42 | 90                    | 36 | 110                         | 44 | 105           | 42 | 220       | 87 | 180           | 71 | 130         | 52 |
| <b>B</b> | 105                             | 42 | 105                           | 42 | 105                         | 42 | 105           | 42 | 105                   | 42 | 180                         | 71 | 105           | 42 | 105       | 42 | 105           | 42 | 105         | 42 |
| <b>C</b> | 85                              | 34 | 85                            | 34 | 85                          | 34 | 85            | 34 | 85                    | 34 | 85                          | 34 | 53            | 21 | 85        | 34 | 85            | 34 | 85          | 34 |



# CIRRUS

MX2560



|          | (2LE/2RE) LOVESEAT<br>CON BRAZO |    | (1LE/1RE) SILLÓN<br>CON BRAZO |    | (2S) LOVESEAT SIN<br>BRAZOS |    | (R) ESQUINERO |    | (S) SILLON SIN BRAZOS |    | (LS/RS) CHAISE CON<br>BRAZO |    | (ST) TABURETE |    | (3D) SOFÁ |    | (2D) LOVESEAT |    | (1D) SILLÓN |    |
|----------|---------------------------------|----|-------------------------------|----|-----------------------------|----|---------------|----|-----------------------|----|-----------------------------|----|---------------|----|-----------|----|---------------|----|-------------|----|
|          | cm                              | in | cm                            | in | cm                          | in | cm            | in | cm                    | in | cm                          | in | cm            | in | cm        | in | cm            | in | cm          | in |
| <b>A</b> | 200                             | 79 | 111                           | 44 | 180                         | 71 | 105           | 42 | 90                    | 36 | 110                         | 44 | 105           | 42 | 220       | 87 | 180           | 71 | 130         | 52 |
| <b>B</b> | 105                             | 42 | 105                           | 42 | 105                         | 42 | 105           | 42 | 105                   | 42 | 180                         | 71 | 105           | 42 | 105       | 42 | 105           | 42 | 105         | 42 |
| <b>C</b> | 85                              | 34 | 85                            | 34 | 85                          | 34 | 85            | 34 | 85                    | 34 | 85                          | 34 | 53            | 21 | 85        | 34 | 85            | 34 | 85          | 34 |

# CIRRUS

MX2560



|          | (2LE/2RE) LOVESEAT CON BRAZO |    | (1LE/1RE) SILLÓN CON BRAZO |    | (2S) LOVESEAT SIN BRAZOS |    | (R) ESQUINERO |    | (S) SILLÓN SIN BRAZOS |    | (LS/RS) CHAISE CON BRAZO |    | (ST) TABURETE |    | (3D) SOFÁ |    | (2D) LOVESEAT |    | (1D) SILLÓN |    |
|----------|------------------------------|----|----------------------------|----|--------------------------|----|---------------|----|-----------------------|----|--------------------------|----|---------------|----|-----------|----|---------------|----|-------------|----|
|          | cm                           | in | cm                         | in | cm                       | in | cm            | in | cm                    | in | cm                       | in | cm            | in | cm        | in | cm            | in | cm          | in |
| <b>A</b> | 200                          | 79 | 111                        | 44 | 180                      | 71 | 105           | 42 | 90                    | 36 | 110                      | 44 | 105           | 42 | 220       | 87 | 180           | 71 | 130         | 52 |
| <b>B</b> | 105                          | 42 | 105                        | 42 | 105                      | 42 | 105           | 42 | 105                   | 42 | 180                      | 71 | 105           | 42 | 105       | 42 | 105           | 42 | 105         | 42 |
| <b>C</b> | 85                           | 34 | 85                         | 34 | 85                       | 34 | 85            | 34 | 85                    | 34 | 85                       | 34 | 53            | 21 | 85        | 34 | 85            | 34 | 85          | 34 |

# CIRRUS

MX2560



|          | (2LE/2RE) LOVESEAT<br>CON BRAZO |    | (1LE/1RE) SILLÓN<br>CON BRAZO |    | (2S) LOVESEAT SIN<br>BRAZOS |    | (R) ESQUINERO |    | (S) SILLÓN SIN BRAZOS |    | (LS/RS) CHAISE CON<br>BRAZO |    | (ST) TABURETE |    | (3D) SOFÁ |    | (2D) LOVESEAT |    | (1D) SILLÓN |    |
|----------|---------------------------------|----|-------------------------------|----|-----------------------------|----|---------------|----|-----------------------|----|-----------------------------|----|---------------|----|-----------|----|---------------|----|-------------|----|
|          | cm                              | in | cm                            | in | cm                          | in | cm            | in | cm                    | in | cm                          | in | cm            | in | cm        | in | cm            | in | cm          | in |
| <b>A</b> | 200                             | 79 | 111                           | 44 | 180                         | 71 | 105           | 42 | 90                    | 36 | 110                         | 44 | 105           | 42 | 220       | 87 | 180           | 71 | 130         | 52 |
| <b>B</b> | 105                             | 42 | 105                           | 42 | 105                         | 42 | 105           | 42 | 105                   | 42 | 180                         | 71 | 105           | 42 | 105       | 42 | 105           | 42 | 105         | 42 |
| <b>C</b> | 85                              | 34 | 85                            | 34 | 85                          | 34 | 85            | 34 | 85                    | 34 | 85                          | 34 | 53            | 21 | 85        | 34 | 85            | 34 | 85          | 34 |

# CIRRUS

MX2560



|          | (2LE/2RE) LOVESEAT<br>CON BRAZO |    | (1LE/1RE) SILLÓN<br>CON BRAZO |    | (2S) LOVESEAT SIN<br>BRAZOS |    | (R) ESQUINERO |    | (S) SILLON SIN BRAZOS |    | (LS/RS) CHAISE CON<br>BRAZO |    | (ST) TABURETE |    | (3D) SOFÁ |    | (2D) LOVESEAT |    | (1D) SILLÓN |    |
|----------|---------------------------------|----|-------------------------------|----|-----------------------------|----|---------------|----|-----------------------|----|-----------------------------|----|---------------|----|-----------|----|---------------|----|-------------|----|
|          | cm                              | in | cm                            | in | cm                          | in | cm            | in | cm                    | in | cm                          | in | cm            | in | cm        | in | cm            | in | cm          | in |
| <b>A</b> | 200                             | 79 | 111                           | 44 | 180                         | 71 | 105           | 42 | 90                    | 36 | 110                         | 44 | 105           | 42 | 220       | 87 | 180           | 71 | 130         | 52 |
| <b>B</b> | 105                             | 42 | 105                           | 42 | 105                         | 42 | 105           | 42 | 105                   | 42 | 180                         | 71 | 105           | 42 | 105       | 42 | 105           | 42 | 105         | 42 |
| <b>C</b> | 85                              | 34 | 85                            | 34 | 85                          | 34 | 85            | 34 | 85                    | 34 | 85                          | 34 | 53            | 21 | 85        | 34 | 85            | 34 | 85          | 34 |

# CIRRUS

MX2560



|          | (2LE/2RE) LOVESEAT CON BRAZO |    | (1LE/1RE) SILLÓN CON BRAZO |    | (2S) LOVESEAT SIN BRAZOS |    | (R) ESQUINERO |    | (S) SILLON SIN BRAZOS |    | (LS/RS) CHAISE CON BRAZO |    | (ST) TABURETE |    | (3D) SOFÁ |    | (2D) LOVESEAT |    | (1D) SILLÓN |    |
|----------|------------------------------|----|----------------------------|----|--------------------------|----|---------------|----|-----------------------|----|--------------------------|----|---------------|----|-----------|----|---------------|----|-------------|----|
|          | cm                           | in | cm                         | in | cm                       | in | cm            | in | cm                    | in | cm                       | in | cm            | in | cm        | in | cm            | in | cm          | in |
| <b>A</b> | 200                          | 79 | 111                        | 44 | 180                      | 71 | 105           | 42 | 90                    | 36 | 110                      | 44 | 105           | 42 | 220       | 87 | 180           | 71 | 130         | 52 |
| <b>B</b> | 105                          | 42 | 105                        | 42 | 105                      | 42 | 105           | 42 | 105                   | 42 | 180                      | 71 | 105           | 42 | 105       | 42 | 105           | 42 | 105         | 42 |
| <b>C</b> | 85                           | 34 | 85                         | 34 | 85                       | 34 | 85            | 34 | 85                    | 34 | 85                       | 34 | 53            | 21 | 85        | 34 | 85            | 34 | 85          | 34 |

# CIRRUS

MX2560

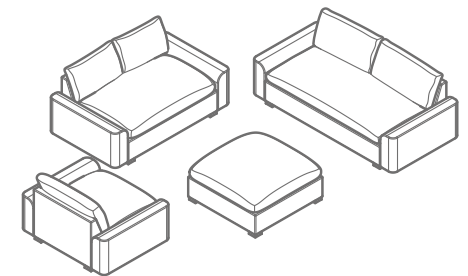
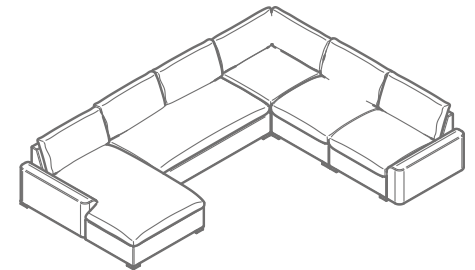
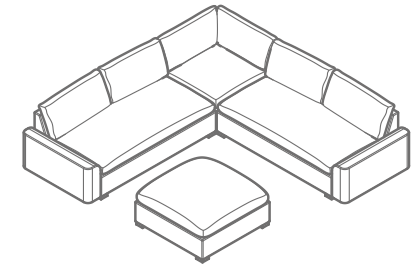
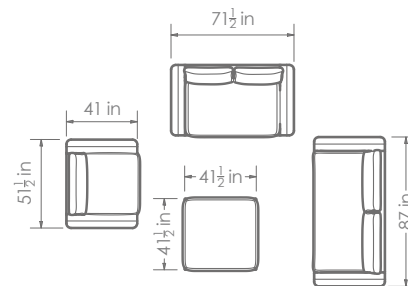
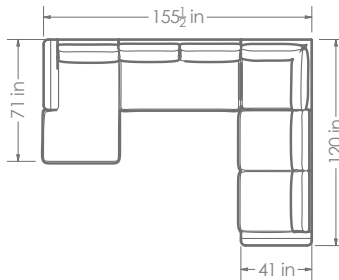
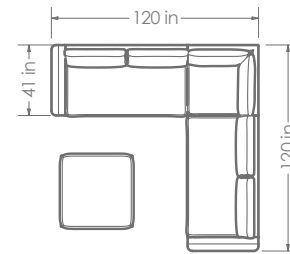
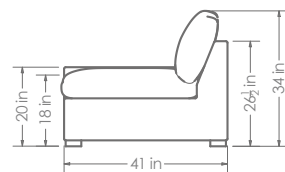
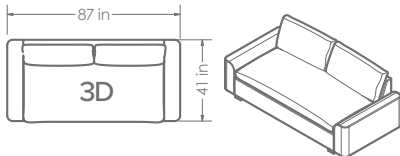
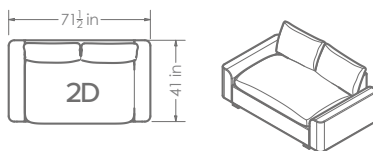
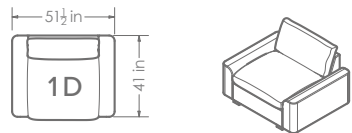
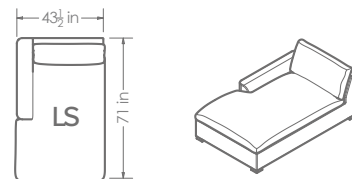
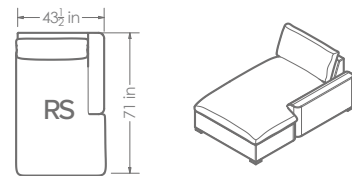
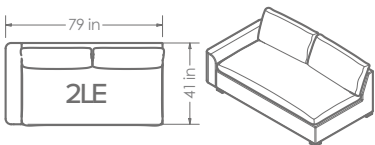
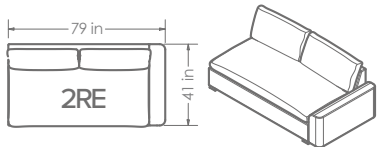
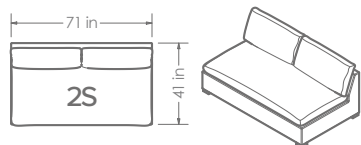
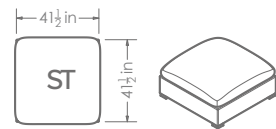
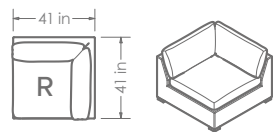
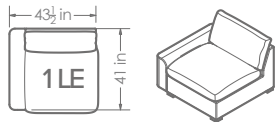
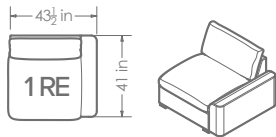
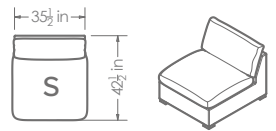

# IOWA

# MX2570

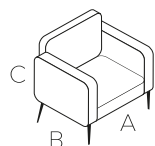

### (3D) SOFÁ

|          | cm  | in |
|----------|-----|----|
| <b>A</b> | 222 | 88 |
| <b>B</b> | 97  | 39 |
| <b>C</b> | 78  | 31 |

### (2D) LOVESEAT

|          | cm  | in |
|----------|-----|----|
| <b>A</b> | 156 | 62 |
| <b>B</b> | 97  | 39 |
| <b>C</b> | 78  | 31 |

### (1D) SILLÓN

|          | cm | in |
|----------|----|----|
| <b>A</b> | 92 | 37 |
| <b>B</b> | 97 | 39 |
| <b>C</b> | 78 | 31 |

IOWA

MX2570

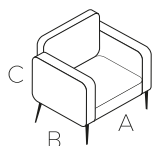

|          | (3D) SOFÁ |    | (2D) LOVESEAT |    | (1D) SILLÓN |    |
|----------|-----------|----|---------------|----|-------------|----|
|          | cm        | in | cm            | in | cm          | in |
| <b>A</b> | 222       | 88 | 156           | 62 | 92          | 37 |
| <b>B</b> | 97        | 39 | 97            | 39 | 97          | 39 |
| <b>C</b> | 78        | 31 | 78            | 31 | 78          | 31 |





# FERRARA

MX2610

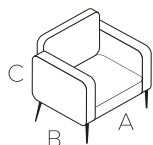

|          | (3D) SOFÁ |     | (2D) LOVESEAT |    | (1D) SILLÓN |    |
|----------|-----------|-----|---------------|----|-------------|----|
|          | cm        | in  | cm            | in | cm          | in |
| <b>A</b> | 252       | 100 | 192           | 76 | 128         | 51 |
| <b>B</b> | 115       | 46  | 115           | 46 | 115         | 46 |
| <b>C</b> | 69        | 28  | 69            | 28 | 69          | 28 |

# FERRARA

MX2610

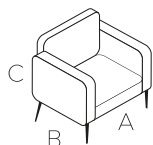

|   | (3D) SOFÁ |     | (2D) LOVESEAT |    | (1D) SILLÓN |    |
|---|-----------|-----|---------------|----|-------------|----|
|   | cm        | in  | cm            | in | cm          | in |
| A | 252       | 100 | 192           | 76 | 128         | 51 |
| B | 115       | 46  | 115           | 46 | 115         | 46 |
| C | 69        | 28  | 69            | 28 | 69          | 28 |

FINLEY

MX2620

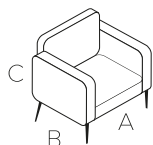

|   | (3D) SOFÁ |    | (2D) LOVESEAT |    | (1D) SILLÓN |    |
|---|-----------|----|---------------|----|-------------|----|
|   | cm        | in | cm            | in | cm          | in |
| A | 222       | 88 | 156           | 62 | 92          | 37 |
| B | 97        | 39 | 97            | 39 | 97          | 39 |
| C | 80        | 32 | 80            | 32 | 80          | 32 |

FINLEY

MX2620

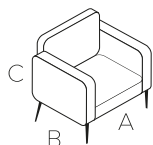

|   | (3D) SOFÁ |    | (2D) LOVESEAT |    | (1D) SILLÓN |    |
|---|-----------|----|---------------|----|-------------|----|
|   | cm        | in | cm            | in | cm          | in |
| A | 222       | 88 | 156           | 62 | 92          | 37 |
| B | 97        | 39 | 97            | 39 | 97          | 39 |
| C | 80        | 32 | 80            | 32 | 80          | 32 |

FINLEY

MX2620

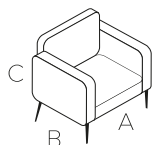

|          | (3D) SOFÁ |    | (2D) LOVESEAT |    | (1D) SILLÓN |    |
|----------|-----------|----|---------------|----|-------------|----|
|          | cm        | in | cm            | in | cm          | in |
| <b>A</b> | 222       | 88 | 156           | 62 | 92          | 37 |
| <b>B</b> | 97        | 39 | 97            | 39 | 97          | 39 |
| <b>C</b> | 80        | 32 | 80            | 32 | 80          | 32 |

# DUSTIN

MX2640

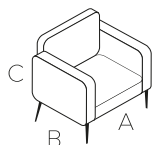

|   | (3D) SOFÁ |    | (2D) LOVESEAT |    | (1D) SILLÓN |    | (1D) SILLÓN GIRATORIO |    | (SC) SOFÁ CAMA |    |
|---|-----------|----|---------------|----|-------------|----|-----------------------|----|----------------|----|
|   | cm        | in | cm            | in | cm          | in | cm                    | in | cm             | in |
| A | 224       | 89 | 159           | 63 | 94          | 38 | 94                    | 38 | 206            | 82 |
| B | 95        | 38 | 95            | 38 | 95          | 38 | 95                    | 38 | 95             | 38 |
| C | 89        | 36 | 89            | 36 | 89          | 36 | 89                    | 36 | 93             | 37 |

# DUSTIN

MX2640

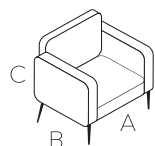

(3D) SOFÁ

|          | cm  | in |
|----------|-----|----|
| <b>A</b> | 224 | 89 |
| <b>B</b> | 95  | 38 |
| <b>C</b> | 89  | 36 |

(2D) LOVESEAT

|  | cm  | in |
|--|-----|----|
|  | 159 | 63 |
|  | 95  | 38 |
|  | 89  | 36 |

(1D) SILLÓN

|  | cm | in |
|--|----|----|
|  | 94 | 38 |
|  | 95 | 38 |
|  | 89 | 36 |

(1D) SILLÓN GIRATORIO

|  | cm | in |
|--|----|----|
|  | 94 | 38 |
|  | 95 | 38 |
|  | 89 | 36 |

(SC) SOFÁ CAMA

|  | cm  | in |
|--|-----|----|
|  | 206 | 82 |
|  | 95  | 38 |
|  | 93  | 37 |



# DUSTIN

# MX2640

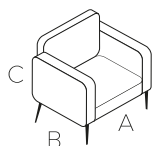

(3D) SOFÁ

|          | cm  | in |
|----------|-----|----|
| <b>A</b> | 224 | 89 |
| <b>B</b> | 95  | 38 |
| <b>C</b> | 89  | 36 |

(2D) LOVESEAT

|          | cm  | in |
|----------|-----|----|
| <b>A</b> | 159 | 63 |
| <b>B</b> | 95  | 38 |
| <b>C</b> | 89  | 36 |

(1D) SILLÓN

|          | cm | in |
|----------|----|----|
| <b>A</b> | 94 | 38 |
| <b>B</b> | 95 | 38 |
| <b>C</b> | 89 | 36 |

(1D) SILLÓN GIRATORIO

|          | cm | in |
|----------|----|----|
| <b>A</b> | 94 | 38 |
| <b>B</b> | 95 | 38 |
| <b>C</b> | 89 | 36 |

(SC) SOFÁ CAMA

|          | cm  | in |
|----------|-----|----|
| <b>A</b> | 206 | 82 |
| <b>B</b> | 95  | 38 |
| <b>C</b> | 93  | 37 |

# STRATUS

MX2680

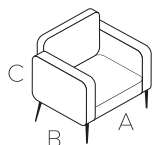

|          | (1L/1RE) SILLÓN<br>CON BRAZO |    | (R) ESQUINERO |    | (S) SILLÓN SIN BRAZOS |    | (ST) TABURETE |    |
|----------|------------------------------|----|---------------|----|-----------------------|----|---------------|----|
|          | cm                           | in | cm            | in | cm                    | in | cm            | in |
| <b>A</b> | 111                          | 44 | 105           | 42 | 90                    | 36 | 105           | 42 |
| <b>B</b> | 105                          | 42 | 105           | 42 | 105                   | 42 | 105           | 42 |
| <b>C</b> | 85                           | 34 | 85            | 34 | 85                    | 34 | 53            | 21 |

# STRATUS

MX2680

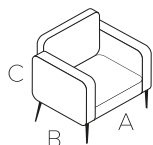

| (1L/1R) SILLÓN CON BRAZO |     | (R) ESQUINERO |     | (S) SILLÓN SIN BRAZOS |     | (ST) TABURETE |     |    |
|--------------------------|-----|---------------|-----|-----------------------|-----|---------------|-----|----|
| cm                       | in  | cm            | in  | cm                    | in  | cm            | in  |    |
| <b>A</b>                 | 111 | 44            | 105 | 42                    | 90  | 36            | 105 | 42 |
| <b>B</b>                 | 105 | 42            | 105 | 42                    | 105 | 42            | 105 | 42 |
| <b>C</b>                 | 85  | 34            | 85  | 34                    | 85  | 34            | 53  | 21 |



# STRATUS

MX2680

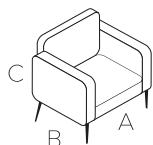

|          | (1L/1R) SILLÓN CON BRAZO |    | (R) ESQUINERO |    | (S) SILLÓN SIN BRAZOS |    | (ST) TABURETE |    |
|----------|--------------------------|----|---------------|----|-----------------------|----|---------------|----|
|          | cm                       | in | cm            | in | cm                    | in | cm            | in |
| <b>A</b> | 111                      | 44 | 105           | 42 | 90                    | 36 | 105           | 42 |
| <b>B</b> | 105                      | 42 | 105           | 42 | 105                   | 42 | 105           | 42 |
| <b>C</b> | 85                       | 34 | 85            | 34 | 85                    | 34 | 53            | 21 |

# KENDALL

MX2690

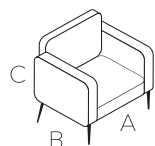

|          | (3D) SOFÁ |    | (2D) LOVESEAT |    | (1D) SILLÓN |    |
|----------|-----------|----|---------------|----|-------------|----|
|          | cm        | in | cm            | in | cm          | in |
| <b>A</b> | 238       | 94 | 168           | 67 | 98          | 39 |
| <b>B</b> | 100       | 40 | 100           | 40 | 100         | 40 |
| <b>C</b> | 83        | 33 | 83            | 33 | 83          | 33 |

# KENDALL

MX2690

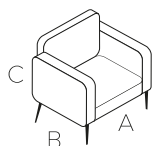

|          | (3D) SOFÁ |    | (2D) LOVESEAT |    | (1D) SILLÓN |    |
|----------|-----------|----|---------------|----|-------------|----|
|          | cm        | in | cm            | in | cm          | in |
| <b>A</b> | 238       | 94 | 168           | 67 | 98          | 39 |
| <b>B</b> | 100       | 40 | 100           | 40 | 100         | 40 |
| <b>C</b> | 83        | 33 | 83            | 33 | 83          | 33 |

# BENNINGTON

MX2710

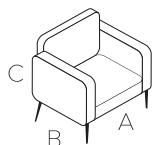

|          | (3D) SOFÁ |    | (2D) LOVESEAT |    | (1D) SILLÓN |    |
|----------|-----------|----|---------------|----|-------------|----|
|          | cm        | in | cm            | in | cm          | in |
| <b>A</b> | 200       | 79 | 160           | 63 | 90          | 36 |
| <b>B</b> | 90        | 36 | 90            | 36 | 90          | 36 |
| <b>C</b> | 83        | 33 | 83            | 33 | 83          | 33 |

# BENNINGTON

MX2710

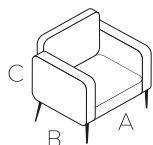

|          | (3D) SOFÁ |    | (2D) LOVESEAT |    | (1D) SILLÓN |    |
|----------|-----------|----|---------------|----|-------------|----|
|          | cm        | in | cm            | in | cm          | in |
| <b>A</b> | 200       | 79 | 160           | 63 | 90          | 36 |
| <b>B</b> | 90        | 36 | 90            | 36 | 90          | 36 |
| <b>C</b> | 83        | 33 | 83            | 33 | 83          | 33 |



# ELLIS

# MX2730

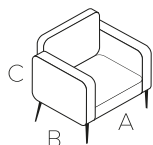

(2LE/2RE) LOVESEAT  
CON BRAZO

|          | cm  | in |
|----------|-----|----|
| <b>A</b> | 225 | 89 |
| <b>B</b> | 104 | 41 |
| <b>C</b> | 97  | 39 |

(LS/RS) CHAISE CON BRAZO

|  | cm  | in |
|--|-----|----|
|  | 125 | 50 |
|  | 180 | 71 |
|  | 97  | 39 |

# ELLIS

MX2730

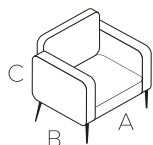

(2LE/2RE) LOVESEAT  
CON BRAZO

|          | cm  | in |
|----------|-----|----|
| <b>A</b> | 225 | 89 |
| <b>B</b> | 104 | 41 |
| <b>C</b> | 97  | 39 |

(LS/RS) CHAISE CON BRAZO

|  | cm  | in |
|--|-----|----|
|  | 125 | 50 |
|  | 180 | 71 |
|  | 97  | 39 |

# KUMO

MX2740



|          | (2LE/2RE) LOVESEAT CON BRAZO |    | (1LE/1RE) SILLÓN CON BRAZO |    | (2S) LOVESEAT SIN BRAZOS |    | (R) ESQUINERO |    | (S) SILLÓN SIN BRAZOS |    | (LS/RS) CHAISE CON BRAZO |    | (ST) TABURETE |    | (3D) SOFÁ |    | (2D) LOVESEAT |    | (1D) SILLÓN |    |
|----------|------------------------------|----|----------------------------|----|--------------------------|----|---------------|----|-----------------------|----|--------------------------|----|---------------|----|-----------|----|---------------|----|-------------|----|
|          | cm                           | in | cm                         | in | cm                       | in | cm            | in | cm                    | in | cm                       | in | cm            | in | cm        | in | cm            | in | cm          | in |
| <b>A</b> | 202                          | 80 | 113                        | 45 | 180                      | 71 | 105           | 42 | 90                    | 36 | 112                      | 45 | 105           | 42 | 224       | 89 | 184           | 73 | 134         | 53 |
| <b>B</b> | 105                          | 42 | 105                        | 42 | 105                      | 42 | 105           | 42 | 105                   | 42 | 180                      | 71 | 105           | 42 | 105       | 42 | 105           | 42 | 105         | 42 |
| <b>C</b> | 85                           | 34 | 85                         | 34 | 85                       | 34 | 85            | 34 | 85                    | 34 | 85                       | 34 | 53            | 21 | 85        | 34 | 85            | 34 | 85          | 34 |

# KUMO

# MX2740



|          | (2LE/2RE) LOVESEAT CON BRAZO |    | (1LE/1RE) SILLÓN CON BRAZO |    | (2S) LOVESEAT SIN BRAZOS |    | (R) ESQUINERO |    | (S) SILLON SIN BRAZOS |    | (LS/RS) CHAISE CON BRAZO |    | (ST) TABURETE |    | (3D) SOFÁ |    | (2D) LOVESEAT |    | (1D) SILLÓN |    |
|----------|------------------------------|----|----------------------------|----|--------------------------|----|---------------|----|-----------------------|----|--------------------------|----|---------------|----|-----------|----|---------------|----|-------------|----|
|          | cm                           | in | cm                         | in | cm                       | in | cm            | in | cm                    | in | cm                       | in | cm            | in | cm        | in | cm            | in | cm          | in |
| <b>A</b> | 202                          | 80 | 113                        | 45 | 180                      | 71 | 105           | 42 | 90                    | 36 | 112                      | 45 | 105           | 42 | 224       | 89 | 184           | 73 | 134         | 53 |
| <b>B</b> | 105                          | 42 | 105                        | 42 | 105                      | 42 | 105           | 42 | 105                   | 42 | 180                      | 71 | 105           | 42 | 105       | 42 | 105           | 42 | 105         | 42 |
| <b>C</b> | 85                           | 34 | 85                         | 34 | 85                       | 34 | 85            | 34 | 85                    | 34 | 85                       | 34 | 53            | 21 | 85        | 34 | 85            | 34 | 85          | 34 |

# KUMO

# MX2740



|          | (2LE/2RE) LOVESEAT CON BRAZO |    | (1LE/1RE) SILLÓN CON BRAZO |    | (2S) LOVESEAT SIN BRAZOS |    | (R) ESQUINERO |    | (S) SILLON SIN BRAZOS |    | (LS/RS) CHAISE CON BRAZO |    | (ST) TABURETE |    | (3D) SOFÁ |    | (2D) LOVESEAT |    | (1D) SILLÓN |    |
|----------|------------------------------|----|----------------------------|----|--------------------------|----|---------------|----|-----------------------|----|--------------------------|----|---------------|----|-----------|----|---------------|----|-------------|----|
|          | cm                           | in | cm                         | in | cm                       | in | cm            | in | cm                    | in | cm                       | in | cm            | in | cm        | in | cm            | in | cm          | in |
| <b>A</b> | 202                          | 80 | 113                        | 45 | 180                      | 71 | 105           | 42 | 90                    | 36 | 112                      | 45 | 105           | 42 | 224       | 89 | 184           | 73 | 134         | 53 |
| <b>B</b> | 105                          | 42 | 105                        | 42 | 105                      | 42 | 105           | 42 | 105                   | 42 | 180                      | 71 | 105           | 42 | 105       | 42 | 105           | 42 | 105         | 42 |
| <b>C</b> | 85                           | 34 | 85                         | 34 | 85                       | 34 | 85            | 34 | 85                    | 34 | 85                       | 34 | 53            | 21 | 85        | 34 | 85            | 34 | 85          | 34 |

# KUMO

MX2740



|          | (2LE/2RE) LOVESEAT CON BRAZO |    | (1LE/1RE) SILLÓN CON BRAZO |    | (2S) LOVESEAT SIN BRAZOS |    | (R) ESQUINERO |    | (S) SILLON SIN BRAZOS |    | (LS/RS) CHAISE CON BRAZO |    | (ST) TABURETE |    | (3D) SOFÁ |    | (2D) LOVESEAT |    | (1D) SILLÓN |    |
|----------|------------------------------|----|----------------------------|----|--------------------------|----|---------------|----|-----------------------|----|--------------------------|----|---------------|----|-----------|----|---------------|----|-------------|----|
|          | cm                           | in | cm                         | in | cm                       | in | cm            | in | cm                    | in | cm                       | in | cm            | in | cm        | in | cm            | in | cm          | in |
| <b>A</b> | 202                          | 80 | 113                        | 45 | 180                      | 71 | 105           | 42 | 90                    | 36 | 112                      | 45 | 105           | 42 | 224       | 89 | 184           | 73 | 134         | 53 |
| <b>B</b> | 105                          | 42 | 105                        | 42 | 105                      | 42 | 105           | 42 | 105                   | 42 | 180                      | 71 | 105           | 42 | 105       | 42 | 105           | 42 | 105         | 42 |
| <b>C</b> | 85                           | 34 | 85                         | 34 | 85                       | 34 | 85            | 34 | 85                    | 34 | 85                       | 34 | 53            | 21 | 85        | 34 | 85            | 34 | 85          | 34 |

# KEYSTONE

MX2750

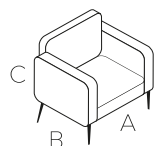

(3D) SOFÁ

|          | cm  | in |
|----------|-----|----|
| <b>A</b> | 232 | 92 |
| <b>B</b> | 101 | 40 |
| <b>C</b> | 75  | 30 |

(2D) LOVESEAT

|  | cm  | in |
|--|-----|----|
|  | 182 | 72 |
|  | 101 | 40 |
|  | 75  | 30 |

# KEYSTONE

MX2750

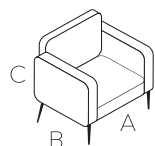

(3D) SOFA

|          | cm  | in |
|----------|-----|----|
| <b>A</b> | 232 | 92 |
| <b>B</b> | 101 | 40 |
| <b>C</b> | 75  | 30 |

(2D) LOVESEAT

|  | cm  | in |
|--|-----|----|
|  | 182 | 72 |
|  | 101 | 40 |
|  | 75  | 30 |



# SKITTLES

MX2780

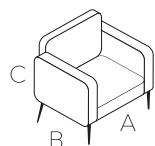

(2LE/2RE) LOVESEAT  
CON BRAZO

|          | cm  | in |
|----------|-----|----|
| <b>A</b> | 188 | 75 |
| <b>B</b> | 112 | 45 |
| <b>C</b> | 93  | 37 |

(S) SILLON SIN BRAZOS

|  | cm  | in |
|--|-----|----|
|  | 75  | 30 |
|  | 112 | 45 |
|  | 93  | 37 |

(ST) TABURETE

|  | cm  | in |
|--|-----|----|
|  | 75  | 30 |
|  | 112 | 45 |
|  | 48  | 19 |

(TBL) MESA

|  | cm  | in |
|--|-----|----|
|  | 46  | 19 |
|  | 112 | 45 |
|  | 63  | 25 |

ZURI

MX2820

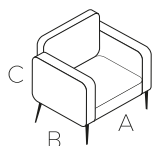

(2LE/2RE) LOVESEAT  
CON BRAZO

|          | cm  | in |
|----------|-----|----|
| <b>A</b> | 200 | 79 |
| <b>B</b> | 97  | 39 |
| <b>C</b> | 74  | 30 |

(LS/RS) CHAISE CON BRAZO

|  | cm  | in |
|--|-----|----|
|  | 114 | 45 |
|  | 180 | 71 |
|  | 74  | 30 |

YUKON

MX2850

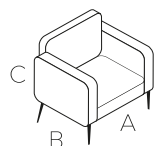

YUKON

MX2850

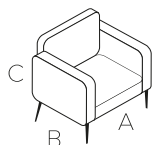

# SAVION

MX2870

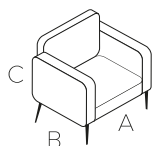

|          | (R) ESQUINERO |    | (S) SILLON SIN BRAZOS |    | (ST) TABURETE |    |
|----------|---------------|----|-----------------------|----|---------------|----|
|          | cm            | in | cm                    | in | cm            | in |
| <b>A</b> | 96            | 38 | 81                    | 32 | 82            | 33 |
| <b>B</b> | 96            | 38 | 96                    | 38 | 96            | 38 |
| <b>C</b> | 94            | 38 | 94                    | 38 | 46            | 19 |

TRISTAN

MX2890

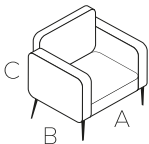

ASHER

MX2920

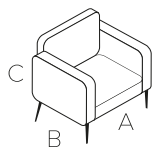

ASHER

MX2920

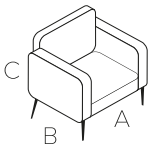



# RANDALL

MX2940

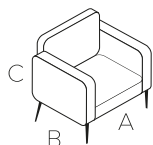

3D SOFÁ

|          | cm  | in |
|----------|-----|----|
| <b>A</b> | 206 | 82 |
| <b>B</b> | 95  | 38 |
| <b>C</b> | 93  | 37 |

(SC) SOFÁ CAMA

|  | cm  | in |
|--|-----|----|
|  | 206 | 82 |
|  | 95  | 38 |
|  | 93  | 37 |

# RANDALL

MX2940

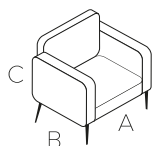

| 3D SOFÁ  |     | (SC) SOFÁ CAMA |     |    |
|----------|-----|----------------|-----|----|
|          | cm  | in             | cm  | in |
| <b>A</b> | 206 | 82             | 206 | 82 |
| <b>B</b> | 95  | 38             | 95  | 38 |
| <b>C</b> | 93  | 37             | 93  | 37 |

# CANOPY

# MX2950

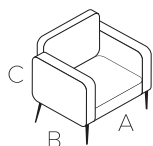

|          | (1L/1RE) SILLÓN<br>CON BRAZO |    | (R) ESQUINERO |    | (S) SILLÓN SIN BRAZOS |    | (ST) TABURETE |    |
|----------|------------------------------|----|---------------|----|-----------------------|----|---------------|----|
|          | cm                           | in | cm            | in | cm                    | in | cm            | in |
| <b>A</b> | 97                           | 39 | 101           | 40 | 77                    | 31 | 77            | 31 |
| <b>B</b> | 101                          | 40 | 101           | 40 | 101                   | 40 | 77            | 31 |
| <b>C</b> | 92                           | 37 | 92            | 37 | 92                    | 37 | 50            | 20 |

# CANOPY

MX2950

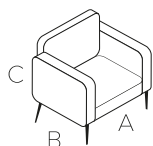

|          | (1LE/1RE) SILLÓN<br>CON BRAZO |    | (R) ESQUINERO |    | (S) SILLÓN SIN BRAZOS |    | (ST) TABURETE |    |
|----------|-------------------------------|----|---------------|----|-----------------------|----|---------------|----|
|          | cm                            | in | cm            | in | cm                    | in | cm            | in |
| <b>A</b> | 97                            | 39 | 101           | 40 | 77                    | 31 | 77            | 31 |
| <b>B</b> | 101                           | 40 | 101           | 40 | 101                   | 40 | 77            | 31 |
| <b>C</b> | 92                            | 37 | 92            | 37 | 92                    | 37 | 50            | 20 |

# CANOPY

MX2950

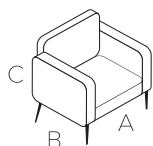

(1LE/1RE) SILLÓN  
CON BRAZO

|          | cm  | in |
|----------|-----|----|
| <b>A</b> | 97  | 39 |
| <b>B</b> | 101 | 40 |
| <b>C</b> | 92  | 37 |

(R) ESQUINERO

|  | cm  | in |
|--|-----|----|
|  | 101 | 40 |
|  | 101 | 40 |
|  | 92  | 37 |

(S) SILLON SIN BRAZOS

|  | cm  | in |
|--|-----|----|
|  | 77  | 31 |
|  | 101 | 40 |
|  | 92  | 37 |

(ST) TABURETE

|  | cm | in |
|--|----|----|
|  | 77 | 31 |
|  | 77 | 31 |
|  | 50 | 20 |

SORRENTO

MX3020

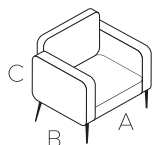

TAMPA

MX3040

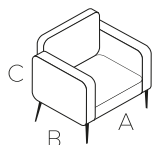

MORROW

---

MX3050

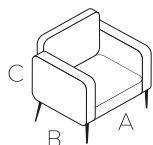



LONDON

MX3130

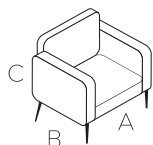

# COPENHAGEN

MX3140

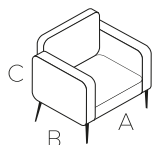

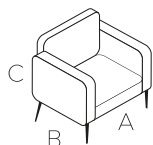

|          | (1L/1RE) SILLÓN<br>CON BRAZO |    | (R) ESQUINERO |    | (S) SILLÓN SIN BRAZOS |    | (ST) TABURETE |    |
|----------|------------------------------|----|---------------|----|-----------------------|----|---------------|----|
|          | cm                           | in | cm            | in | cm                    | in | cm            | in |
| <b>A</b> | 117                          | 47 | 111           | 44 | 87                    | 35 | 87            | 35 |
| <b>B</b> | 111                          | 44 | 111           | 44 | 111                   | 44 | 87            | 35 |
| <b>C</b> | 96                           | 38 | 96            | 38 | 96                    | 38 | 52            | 21 |

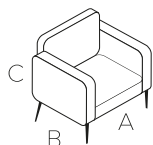

|          | (1L/1RE) SILLÓN<br>CON BRAZO |    | (R) ESQUINERO |    | (S) SILLÓN SIN BRAZOS |    | (ST) TABURETE |    |
|----------|------------------------------|----|---------------|----|-----------------------|----|---------------|----|
|          | cm                           | in | cm            | in | cm                    | in | cm            | in |
| <b>A</b> | 117                          | 47 | 111           | 44 | 87                    | 35 | 87            | 35 |
| <b>B</b> | 111                          | 44 | 111           | 44 | 111                   | 44 | 87            | 35 |
| <b>C</b> | 96                           | 38 | 96            | 38 | 96                    | 38 | 52            | 21 |

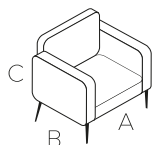

|          | (1L/1RE) SILLÓN<br>CON BRAZO |    | (R) ESQUINERO |    | (S) SILLÓN SIN BRAZOS |    | (ST) TABURETE |    |
|----------|------------------------------|----|---------------|----|-----------------------|----|---------------|----|
|          | cm                           | in | cm            | in | cm                    | in | cm            | in |
| <b>A</b> | 117                          | 47 | 111           | 44 | 87                    | 35 | 87            | 35 |
| <b>B</b> | 111                          | 44 | 111           | 44 | 111                   | 44 | 87            | 35 |
| <b>C</b> | 96                           | 38 | 96            | 38 | 96                    | 38 | 52            | 21 |

ONEIRA

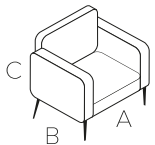

# ACCENT CHAIRS



ASIA

CM130

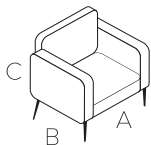

(ID) SILLÓN

cm in

|          |    |    |
|----------|----|----|
| <b>A</b> | 70 | 28 |
| <b>B</b> | 82 | 33 |
| <b>C</b> | 85 | 34 |



VAIL

CM150

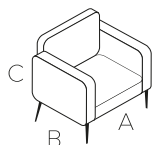

(ID) SILLÓN

|          | cm  | in |
|----------|-----|----|
| <b>A</b> | 74  | 30 |
| <b>B</b> | 79  | 32 |
| <b>C</b> | 101 | 40 |

WEST

CM160

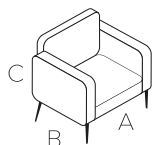

(ID) SILLÓN

|          | cm | in |
|----------|----|----|
| <b>A</b> | 93 | 37 |
| <b>B</b> | 90 | 36 |
| <b>C</b> | 95 | 38 |

(SW) SILLÓN GIRATORIO

|          | cm | in |
|----------|----|----|
| <b>A</b> | 93 | 37 |
| <b>B</b> | 90 | 36 |
| <b>C</b> | 98 | 39 |

# SMILE

CM180

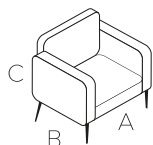

(1D) SILLÓN

|          | cm | in |
|----------|----|----|
| <b>A</b> | 80 | 32 |
| <b>B</b> | 82 | 33 |
| <b>C</b> | 82 | 33 |

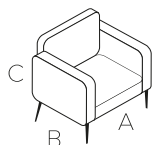

|          | (1D) SILLÓN |    | (5T) TABURETE |    |
|----------|-------------|----|---------------|----|
|          | cm          | in | cm            | in |
| <b>A</b> | 102         | 41 | 84            | 34 |
| <b>B</b> | 85          | 34 | 54            | 22 |
| <b>C</b> | 100         | 40 | 43            | 17 |

CIRCLE

CM210

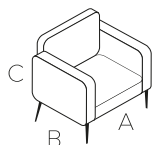

(1D) SILLÓN

cm in

|          |     |    |
|----------|-----|----|
| <b>A</b> | 110 | 44 |
| <b>B</b> | 110 | 44 |
| <b>C</b> | 35  | 14 |

LOLA

CM230

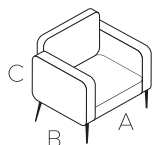

|          | (1D) SILLÓN |    | (SW) SILLÓN GIRATORIO |    |
|----------|-------------|----|-----------------------|----|
|          | cm          | in | cm                    | in |
| <b>A</b> | 87          | 35 | 87                    | 35 |
| <b>B</b> | 92          | 37 | 92                    | 37 |
| <b>C</b> | 98          | 39 | 100                   | 40 |

ALEX

CM240

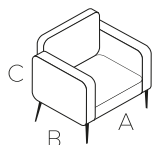

|          | (ID) SILLÓN |    | (SW) SILLÓN GIRATORIO |    |
|----------|-------------|----|-----------------------|----|
|          | cm          | in | cm                    | in |
| <b>A</b> | 82          | 33 | 82                    | 33 |
| <b>B</b> | 78          | 31 | 78                    | 31 |
| <b>C</b> | 96          | 38 | 95                    | 38 |

VIVA

CM250

swivel

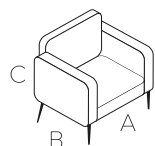

(SW) SILLÓN GIRATORIO

|   | cm | in |
|---|----|----|
| A | 76 | 30 |
| B | 78 | 31 |
| C | 76 | 30 |



BARY

CM270

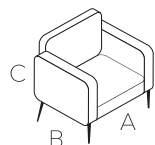

(ST) TABURETE

cm in

|          |     |    |
|----------|-----|----|
| <b>A</b> | 114 | 45 |
| <b>B</b> | 114 | 45 |
| <b>C</b> | 40  | 16 |

# SIENA

CM290

swivel

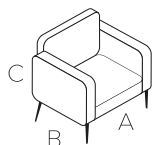

(SW) SILLÓN GIRATORIO

|          | cm | in |
|----------|----|----|
| <b>A</b> | 74 | 30 |
| <b>B</b> | 87 | 35 |
| <b>C</b> | 92 | 37 |

# TURIN

CM300



CM301

swivel

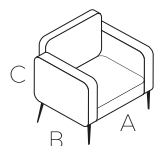

(1D) SILLÓN

|          | cm | in |
|----------|----|----|
| <b>A</b> | 78 | 31 |
| <b>B</b> | 80 | 32 |
| <b>C</b> | 90 | 36 |

(SW) SILLÓN GIRATORIO

|          | cm | in |
|----------|----|----|
| <b>A</b> | 78 | 31 |
| <b>B</b> | 80 | 32 |
| <b>C</b> | 90 | 36 |

(SW) SILLÓN GIRATORIO

|          | cm | in |
|----------|----|----|
| <b>A</b> | 78 | 31 |
| <b>B</b> | 80 | 32 |
| <b>C</b> | 90 | 36 |

# FLORENCE

CM310

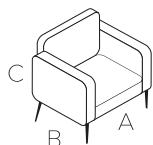

(1D) SILLÓN

cm in

|          |     |    |
|----------|-----|----|
| <b>A</b> | 74  | 30 |
| <b>B</b> | 85  | 34 |
| <b>C</b> | 104 | 41 |

PARIS

CM320

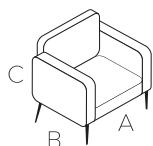

(1D) SILLÓN

|          | cm  | in |
|----------|-----|----|
| <b>A</b> | 78  | 31 |
| <b>B</b> | 85  | 34 |
| <b>C</b> | 106 | 42 |

# PALERMO

CM330

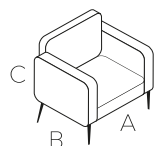

(1D) SILLÓN

cm in

|          |    |    |
|----------|----|----|
| <b>A</b> | 85 | 34 |
| <b>B</b> | 90 | 36 |
| <b>C</b> | 84 | 34 |

# PALERMO

CM330

swivel

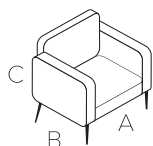

(SW) SILLÓN GIRATORIO

|          | cm | in |
|----------|----|----|
| <b>A</b> | 85 | 34 |
| <b>B</b> | 90 | 36 |
| <b>C</b> | 82 | 33 |

# MALIBU

CM350

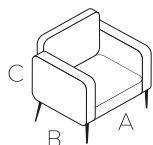

(ID) SILLÓN

|          | cm | in |
|----------|----|----|
| <b>A</b> | 77 | 31 |
| <b>B</b> | 78 | 31 |
| <b>C</b> | 88 | 35 |



# KETCHUM

CM360

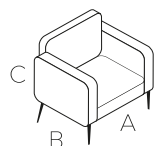

(1D) SILLÓN

|          | cm | in |
|----------|----|----|
| <b>A</b> | 75 | 30 |
| <b>B</b> | 86 | 34 |
| <b>C</b> | 93 | 37 |

# PHOENIX

CM380

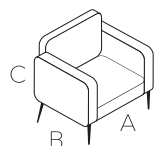

(1D) SILLÓN

|          | cm | in |
|----------|----|----|
| <b>A</b> | 80 | 32 |
| <b>B</b> | 88 | 35 |
| <b>C</b> | 90 | 36 |

# WASHINGTON

CM390

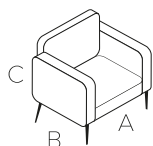

(1D) SILLÓN

|   | cm | in |
|---|----|----|
| A | 76 | 30 |
| B | 83 | 33 |
| C | 85 | 34 |

# KNOXVILLE

CM420

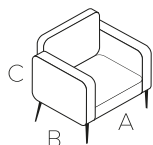

(2D) LOVESEAT

|          | cm  | in |
|----------|-----|----|
| <b>A</b> | 133 | 53 |
| <b>B</b> | 82  | 33 |
| <b>C</b> | 80  | 32 |

(1D) SILLÓN

|          | cm | in |
|----------|----|----|
| <b>A</b> | 73 | 29 |
| <b>B</b> | 82 | 33 |
| <b>C</b> | 80 | 32 |

# KANSAS

CM430

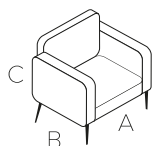

(2D) LOVESEAT

cm in

|          |     |    |
|----------|-----|----|
| <b>A</b> | 136 | 54 |
| <b>B</b> | 90  | 36 |
| <b>C</b> | 88  | 35 |

# KANSAS

CM430

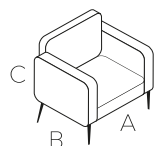

(2D) LOVESEAT

|          | cm  | in |
|----------|-----|----|
| <b>A</b> | 136 | 54 |
| <b>B</b> | 90  | 36 |
| <b>C</b> | 88  | 35 |

(1D) SILLÓN

|          | cm | in |
|----------|----|----|
| <b>A</b> | 76 | 30 |
| <b>B</b> | 90 | 36 |
| <b>C</b> | 88 | 35 |

MAINE

CM450

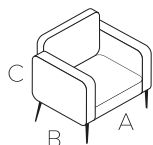

(ST) TABURETE

cm in

|          |    |    |
|----------|----|----|
| <b>A</b> | 44 | 18 |
| <b>B</b> | 44 | 18 |
| <b>C</b> | 50 | 20 |

VERONA

CM460

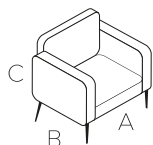

(1D) SILLÓN

|          | cm | in |
|----------|----|----|
| <b>A</b> | 80 | 32 |
| <b>B</b> | 82 | 33 |
| <b>C</b> | 72 | 29 |



TAOS

CM470



swivel

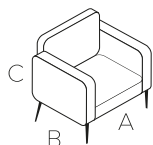

|          | (ID) SILLÓN |    | (SW) SILLÓN GIRATORIO |    |
|----------|-------------|----|-----------------------|----|
|          | cm          | in | cm                    | in |
| <b>A</b> | 77          | 31 | 77                    | 31 |
| <b>B</b> | 84          | 34 | 84                    | 34 |
| <b>C</b> | 89          | 36 | 89                    | 36 |

# TAHOE

CM480

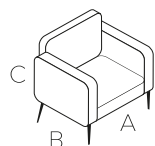

(1D) SILLÓN

cm in

|          |    |    |
|----------|----|----|
| <b>A</b> | 80 | 32 |
| <b>B</b> | 77 | 31 |
| <b>C</b> | 82 | 33 |

# SEATTLE

CM490

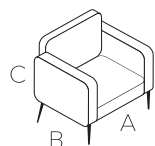

(1D) SILLÓN

|          | cm | in |
|----------|----|----|
| <b>A</b> | 73 | 29 |
| <b>B</b> | 70 | 28 |
| <b>C</b> | 78 | 31 |

# CHICAGO

CM510

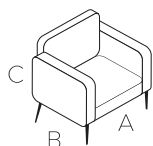

(1D) SILLÓN

cm in

|          |    |    |
|----------|----|----|
| <b>A</b> | 76 | 30 |
| <b>B</b> | 76 | 30 |
| <b>C</b> | 85 | 34 |

# BUFFALO

CM520

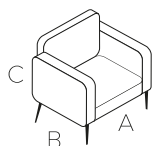

(1D) SILLÓN

|          | cm  | in |
|----------|-----|----|
| <b>A</b> | 78  | 31 |
| <b>B</b> | 84  | 34 |
| <b>C</b> | 107 | 43 |

# MARFA

CM530

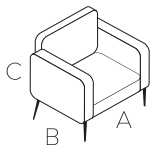

(1D) SILLÓN

cm in

|          |    |    |
|----------|----|----|
| <b>A</b> | 73 | 29 |
| <b>B</b> | 70 | 28 |
| <b>C</b> | 78 | 31 |

# MONTANA

CM630

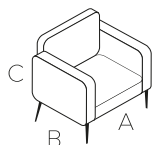

(1D) SILLÓN

cm in

|          |     |    |
|----------|-----|----|
| <b>A</b> | 81  | 32 |
| <b>B</b> | 95  | 38 |
| <b>C</b> | 118 | 47 |

# MONTANA

CM631

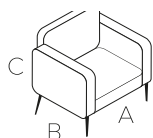

(1D) SILLÓN

|          | cm  | in |
|----------|-----|----|
| <b>A</b> | 81  | 32 |
| <b>B</b> | 95  | 38 |
| <b>C</b> | 118 | 47 |



VENICE

CM640

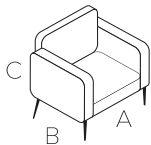

(ST) TABURETE

|          | cm | in |
|----------|----|----|
| <b>A</b> | 97 | 39 |
| <b>B</b> | 97 | 39 |
| <b>C</b> | 50 | 20 |

# MARSHALL

CM680

swivel

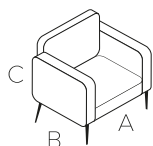

(SW) SILLÓN GIRATORIO

cm in

|          |    |    |
|----------|----|----|
| <b>A</b> | 85 | 34 |
| <b>B</b> | 88 | 35 |
| <b>C</b> | 83 | 33 |

# HOUSTON

CM690

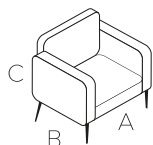

(SW) SILLÓN GIRATORIO

cm in

|          |    |    |
|----------|----|----|
| <b>A</b> | 75 | 30 |
| <b>B</b> | 84 | 34 |
| <b>C</b> | 91 | 36 |

# HARRIS

CM700

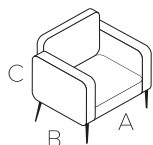

(IDR) SILLÓN RECLINABLE

cm in

**A** 82 33

**B** 84 34

**C** 107 43

# MORGAN

CM710

swivel

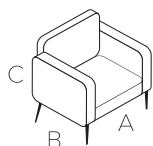

(SW) SILLÓN GIRATORIO

cm in

|          |    |    |
|----------|----|----|
| <b>A</b> | 85 | 34 |
| <b>B</b> | 82 | 33 |
| <b>C</b> | 86 | 34 |

CM780

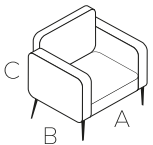

CM820

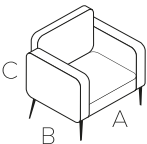

MAX



LSG400

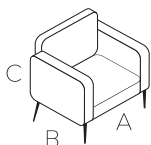



OLLIE

LSG500

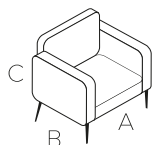

**BEDS**



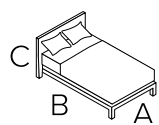

|          | (KB) KING SIZE |    | (QB) QUEEN SIZE |    | (DB) MATRIMONIAL |    |
|----------|----------------|----|-----------------|----|------------------|----|
|          | cm             | in | cm              | in | cm               | in |
| <b>A</b> | 247            | 98 | 220             | 87 | 193              | 76 |
| <b>B</b> | 239            | 95 | 239             | 95 | 239              | 95 |
| <b>C</b> | 125            | 50 | 125             | 50 | 125              | 50 |

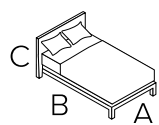

|          | (KB) KING SIZE |    | (QB) QUEEN SIZE |    | (DB) MATRIMONIAL |    |
|----------|----------------|----|-----------------|----|------------------|----|
|          | cm             | in | cm              | in | cm               | in |
| <b>A</b> | 234            | 93 | 184             | 73 | 169              | 67 |
| <b>B</b> | 233            | 92 | 233             | 92 | 233              | 92 |
| <b>C</b> | 104            | 41 | 104             | 41 | 104              | 41 |

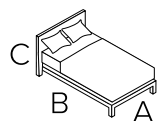

|          | (KB) KING SIZE |     | (QB) QUEEN SIZE |    | (DB) MATRIMONIAL |    |
|----------|----------------|-----|-----------------|----|------------------|----|
|          | cm             | in  | cm              | in | cm               | in |
| <b>A</b> | 260            | 103 | 210             | 83 | 195              | 77 |
| <b>B</b> | 218            | 86  | 218             | 86 | 218              | 86 |
| <b>C</b> | 103            | 41  | 103             | 41 | 103              | 41 |



MIIRZA



[www.miirza.com](http://www.miirza.com)

